



**Lighting Your Way
Since '79**



Full Line Catalog



Table of Contents

TURN SIGNAL SWITCHES, FLASHERS, RELAYS & CONNECTORS

Universal Turn Signal Switches	4-5	Flashers and Relays	19
OEM Replacement Turn Signal Switches	6-18	Flasher Connectors	20

LED LIGHTING

NEW: Volvo Sunvisor Marker Lights	21	High Count Multi-Diode LED Lamps	28
Heavy-Duty Lighting Plan-O-Gram	22	Multi-Diode Clearance and Marker Lamps	29-30
7" LED Warning Lamps	23	LED Stop/Tail/Turn Signal Lamps	30-37
7" LED Backup Lamp	24	LED Clearance and Marker Lamps	38-42
7" LED Stop/Tail/Turn Signal Lamp	25	LED 3/4" Micro-Marker Lamps	43
Single and Dual-Diode S/T/T and C/M Lamps	26-27		

STOP, TAIL, TURN SIGNAL LAMPS

Sealed Stop/Tail/Turn Signal Lamps	44-46	OEM Rear Combination Lamps	50
Oval Lamps in Stainless Panels	47	OEM Metri-Pack Rear Combination Lamps	51
Replaceable Bulb Rear Lamps	48	LED OEM Rear Combination Lamps	52

TURN SIGNAL LAMPS

Die Cast Front and Rear Turn Signal Lamps	54	LED Front Turn Signal Lamps	58
OEM Front Turn Signal Lamps	55-57	Mid-Turn Signal Lamps	59

CLEARANCE/MARKER LAMPS

Cab Marker Lamps	60-62	Armored Clearance/Marker Lamps	71
Sealed Clearance/Marker Lamps	63-69	Identification Bars	72-75
Replaceable Bulb Clearance/Marker Lamps	70		

AUXILIARY LIGHTING & HEAVY-DUTY CAMERA SYSTEMS

Fog Lamps	76	Side-View Mirror Camera System	87
Rubber Housing Work Lamps	76-77	Heavy-Duty Cameras	88
7" 2D1 PAR56 Headlamp	78	Heavy-Duty LCD Monitors	89
Heavy-Duty Camera/Monitor Systems	79-83	LED Off-Road and Auxiliary Work Lights	90-98
Trailer Camera Connection Systems	84-86		

BACK-UP, DOME, UTILITY LAMPS, LICENSE PLATE LAMPS

Dome and Utility Lamps	99	License Plate Lamps	101
Back-Up Lamps	100	License Plate Lamps and Brackets	102

STROBE WARNING LAMPS, PLUG ADAPTERS AND HARNESSSES

Strobe/Warning Lighting	103-104	Pigtails	107
Self-Contained Strobe/Warning Lights	104	Plug Adaptors	108
Portable Strobe/Warning Lights	105	Harness and Metri-Pack Connectors	109
Universal LED/Submersible Trailer Light Kit	106		

MOUNTING ACCESSORIES, EMERGENCY LIGHTING, REFLEX REFLECTORS & CONSPICUITY TAPE

Mounting Grommets and Grommet/Plug Kits	110	Lamp, Bulb, Fuse Hi-Way Safety Case	113
Mounting Brackets	111	Reflex Reflectors (Round and Rectangular)	114-115
Stainless Steel Panels for Oval Lamps	112	Narrow Rail Acrylic Reflector	115
Chrome Bezels	112	Conspicuity Tape (Rolls and Strips)	116-117
Highway Emergency (Fusee Cases, Brackets)	113		

ACCESSORIES, LED DISPLAYS, LENSES

Junction Terminal Blocks	118	Circuit Tester	119
Back-Up Alarms	118	Caution Triangles and Safety Arrows	120
Document Holders	118	Replacement Lenses	121
King Pin and Glad Hand Locks	119		
Glad Hand Grips	119		

Product Interchange	122-128
Part Number to Page Index	129-131
Federal Regulations	132-139



NEW

Mack Truck Turns Signal Switches
Page 7

Volvo Sunvisor Lamps
Page 21

NEW

LED Work Lamps with
CMOS Color Camera
Page 79

NEW

Magnet Mount for LED Work Lamps
Page 83

NEW

Cargo Trailer Camera Systems
Page 84

NEW

Heavy Duty Video
Monitors (1-4 Cameras)
Page 89

Palanca Direccionales

All turn signal switches 12V standard



900

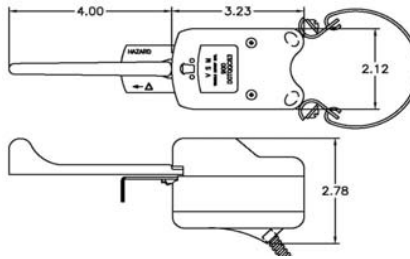

Features:

- Durable die cast construction
- Die cast handle with heavy duty flare tab
- Heavy gauge mounting strap and hardware
- Long lasting contacts extend switch life
- Heavy duty wiring



900HD

vsm900 7-Wire Harness, Flat Black

- For use on vehicles having combination stop and turn signal lamps and requiring brake light circuit

Replacement Bulb: 53

vsm900HD 7-Wire, Flat Black-Heavy Duty Handle

Replacement Bulb: 53

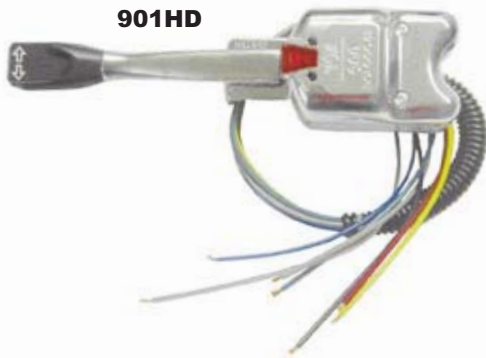

901HD

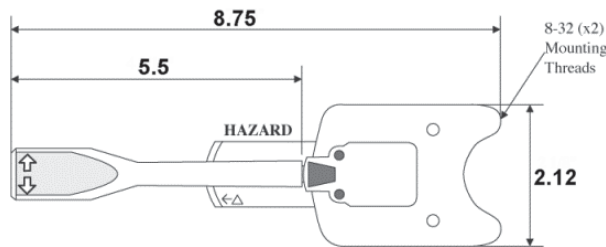

vsm901 7-Wire, Chrome Finish With Std. Handle

vsm901HD 7-Wire, Chrome Finish With HD Handle

- Heavy die cast construction
- Highest tested reliability in the industry

Replacement Bulb: 53

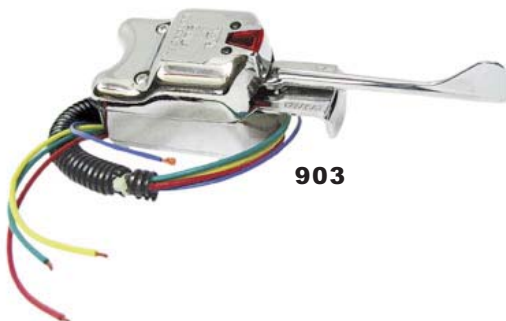

903

vsm902 4-Wire Harness Flat Black Housing

vsm903 4-Wire Harness Chrome Housing

For use on vehicles with separate, rear, stop and turn signal lamps.

- Separate green pilot lights to indicate left and right turns
- Separate red pilot light for hazard warning
- Simultaneously flashes turn signal lamps for hazard warning
- Ten bulb capacity for hazard warning, five bulbs per side for turn signal flashing
- Positive pilot action
- Does not include flasher or fuse-in-line

Replacement Bulb: 53

HEAVY DUTY OEM DIE CAST UNIVERSAL TURN SIGNAL SWITCHES

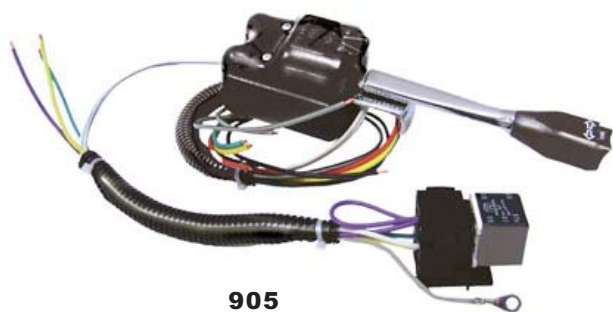

905

vsm905 11-Wire Harness, Flat Black Housing **vsm905C 11-Wire Harness, Chrome Housing**

- With built in push button, high/low beam switch
- Upgrades the 900 switch by moving high/low beam selector switch from floor to handle
- 11 wire harness with relay
- Same ease of operation and maintenance as vsm900
- No pilot lights



910

vsm910 7-Wire Harness, Flat Black Housing

- Heavy Duty Chrome Handle
- Heavy duty contacts
- 16-bulb capacity for hazard warning
- 8-bulbs per side for turn signal
- With pilot light



915

vsm915 11-Wire Harness with Relay, Flat Black Housing

- Heavy Duty contacts and Relay with High/Low Beam Switch
- For use on vehicles having combination stop and turn signal lamps requiring brake light circuit
- HD 16 bulb capacity for hazard warning, 8 bulbs per side for turn signal flashing
- No pilot lights
- Increased wire gauge for heavier loads
- Die cast metal housing and handle
- Retains same ease of operation and maintenance as vsm900
- Flasher and fuse line not included



935

vsm935 Heavy Duty Brake Light Override System

- Allows brake lights to function in rear hazard mode
- 16 bulb capacity
- Flasher and fuse line not included

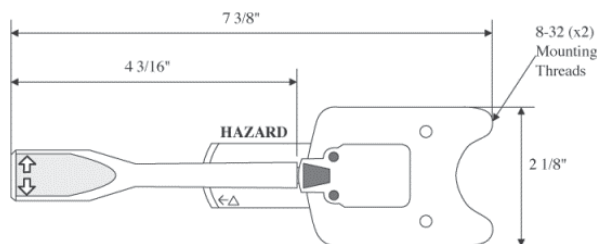



OEM Turn Signal Switches

Palancas Direccionales Para Equipo Original

VSM/OEM REPLACEMENT CHART

FORD

VSM #	FORD #
900Y170	E5HT13B302AA E5HZ13341A
900Y177	E9HT13B302AB E9HZ13341E

FREIGHTLINER

VSM #	FREIGHTLINER #
999124	680-545-01-24
999490	A14-13495-000
999491	A06-22743-002***
999495	A14-13495-005
999496	A06-44025-000***
999177	GR01481177
999182	GR01481182
915Y113	A06-13867-002 A06-17126-000
915Y108	681-545-00-24

KENWORTH

VSM #	KENWORTH #
999836	480836
999839	480839H
999295	K301295-3
900Y96	K-301-182
915Y103	K301D230 18500D044
915Y704	K301-357
900Y209	K301D182

MACK

VSM #	MACK #
999574	1MR574
999575	1MR575
910Y601	1MR572
915Y703	1MR571
900Y73	1MR2201P2 1MR2201P1
900Y150	1MR3412 1MR3412P2

***NEW SWITCHES

NAVISTAR

VSM #	NAVISTAR #
900Y206	1663595C91
900Y114	1663595C91 775863C93 523848C91
999392	3544933C92
915Y118	1616317C91

PETERBILT

VSM #	PETERBILT #
999827	480827G
915Y104	16-03827
915Y114	16-04415
915Y124	16-06432
915Y121	16-05713

VSM UNIVERSAL SWITCHES

999282	Universal
900	Universal
905	Universal

VOLVO/GM

VSM #	VOLVO/GM #
900Y129	84401-0005
915Y105	84401-3203
915Y116	3081534
915Y117	3081533 84401-0020
988172	3172172***
988173	3172173***
988838	20797838***

WESTERN STAR

VSM #	WESTERN STAR #
918Y116	84401-3421
918Y994	84401-3429
918Y998	84401-3431



ALL MAKES. ONE SOURCE.

All Makes. One Source. The thought became a concept and VSM made the idea a reality. VSM's turn signal switches feature modular plug-in harnesses that allow OEM replacements without rewiring for virtually every heavy duty vehicle make. They are highly reliable, having survived over one million cycles and proven cost effective under actual driving tests.

Features

- Exceeds class A, SAE, QQC, and FMVSS108 specs
- Heavy Duty unitized construction
- Positive detent for better "driver feel" when signalling
- Capacity to flash 18 bulbs in hazard mode, 9 bulbs per side for turn signal flashing
- Heavy Duty hazard tab for long life and reliability in 4-way flasher operation
- Integrated stop lamp circuitry
- Durable, long lasting contacts for longer life
- Handle lift-to-dim high/low beam selector
- Integral mounting bracket provides a sturdy assembly
- Grease-free contact area

OEM Turn Signal Switches



Newly Available Mack Turn Signal Switches

Vehicle Safety Manufacturing is pleased to announce the aftermarket availability of three popular turn signal switches specific to Mack trucks. VSM part numbers **999587**, **999589**, and **915Y702** offer turn signal switch coverage for our dealers for the most popular trucks on the road today.

VSM999587 Mack Turn Signal Switch

Replacement for 82406821



VSM999589 Mack Turn Signal Switch with Self-Cancel

Replacement for 21750459



VSM915Y702

Mack Turn Signal Switch

Replacement for 21475716



FREIGHTLINER



VSM999177

Replacement Turn Signal Switch For Freightliner GR01481177



VSM999490

Replacement Turn Signal Switch For Freightliner A14-13495-000
Handle is shadow gray in color.



VSM999495

Replacement Turn Signal Switch For Freightliner A14-13495-005
Handle is black in color.

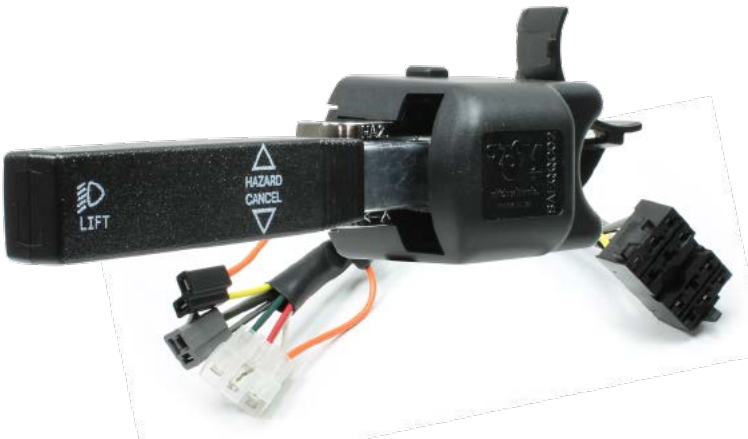

VSM999182

Replacement Turn Signal Switch For Freightliner GR01481182



VSM915Y108

Replacement Turn Signal Switch For Freightliner 681-545-00-24

- 8-wire harness
- Handle features push-button high/low beam selector
- 16 bulb capacity for hazard warning
- 8 bulbs per side for turn signal flashing



VSM915Y113

Replacement Turn Signal Switch For Freightliner A06-13867-002;
A06-17126-000

- 10-wire harness
- Handle features push-button high/low beam selector
- 16 bulb capacity for hazard warning
- 8 bulbs per side for turn signal flashing

FREIGHTLINER



VSM999124

Replacement Turn Signal Switch For:
Freightliner REF # 680-545-01-24



VSM999491

Replacement Turn Signal Switch For:
Freightliner REF # A06-22743-002
Handle is shadow gray in color



VSM999496

Replacement Turn Signal Switch For:
Freightliner REF # A06-44025-000
Handle is black in color



OEM Turn Signal Switches

Palancas Direccionales Para Equipo Original

All turn signal switches 12V standard

VOLVO

OEM Turn Signal Switches

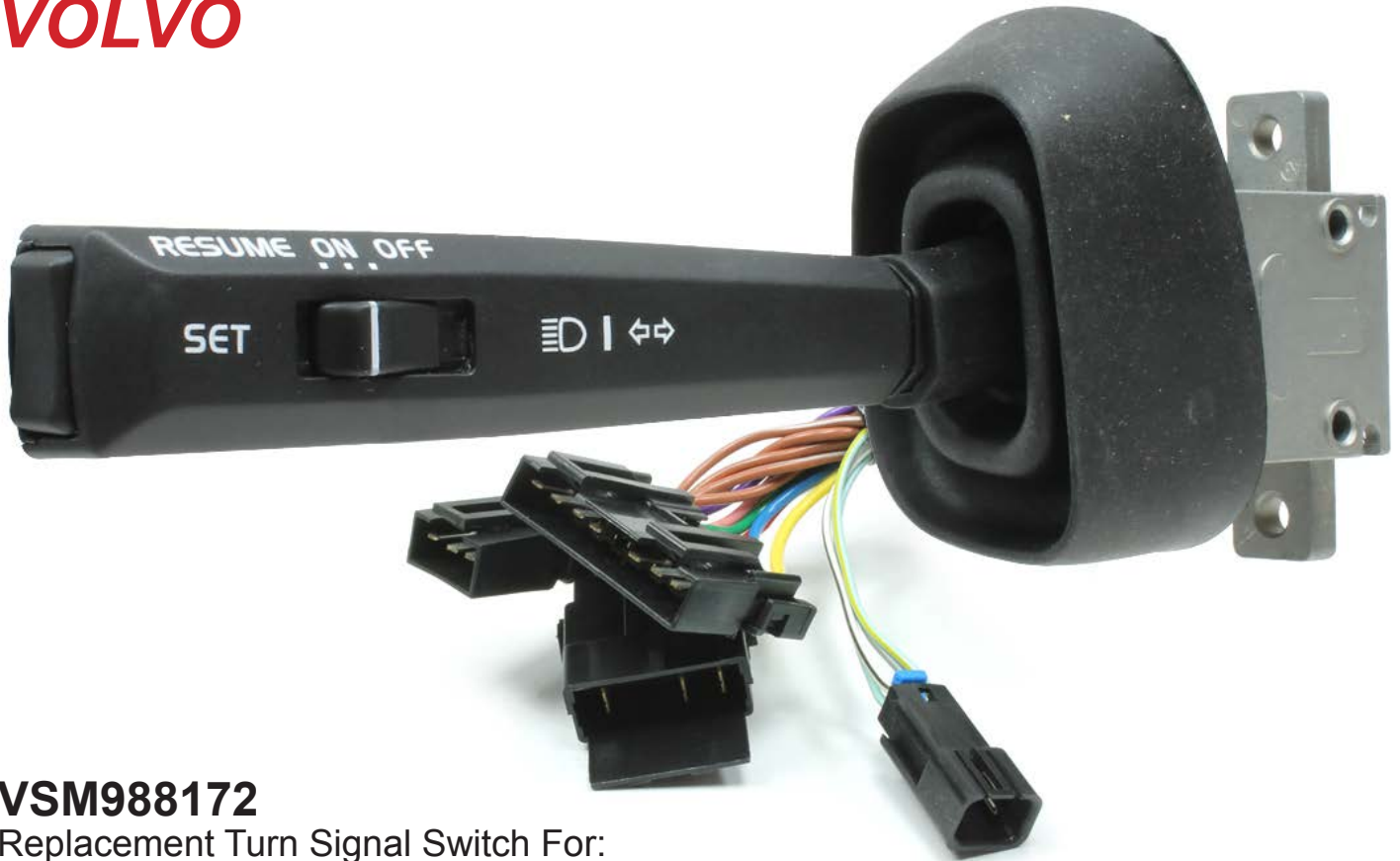

VSM988172
Replacement Turn Signal Switch For:
Volvo OEM REF # 3172172

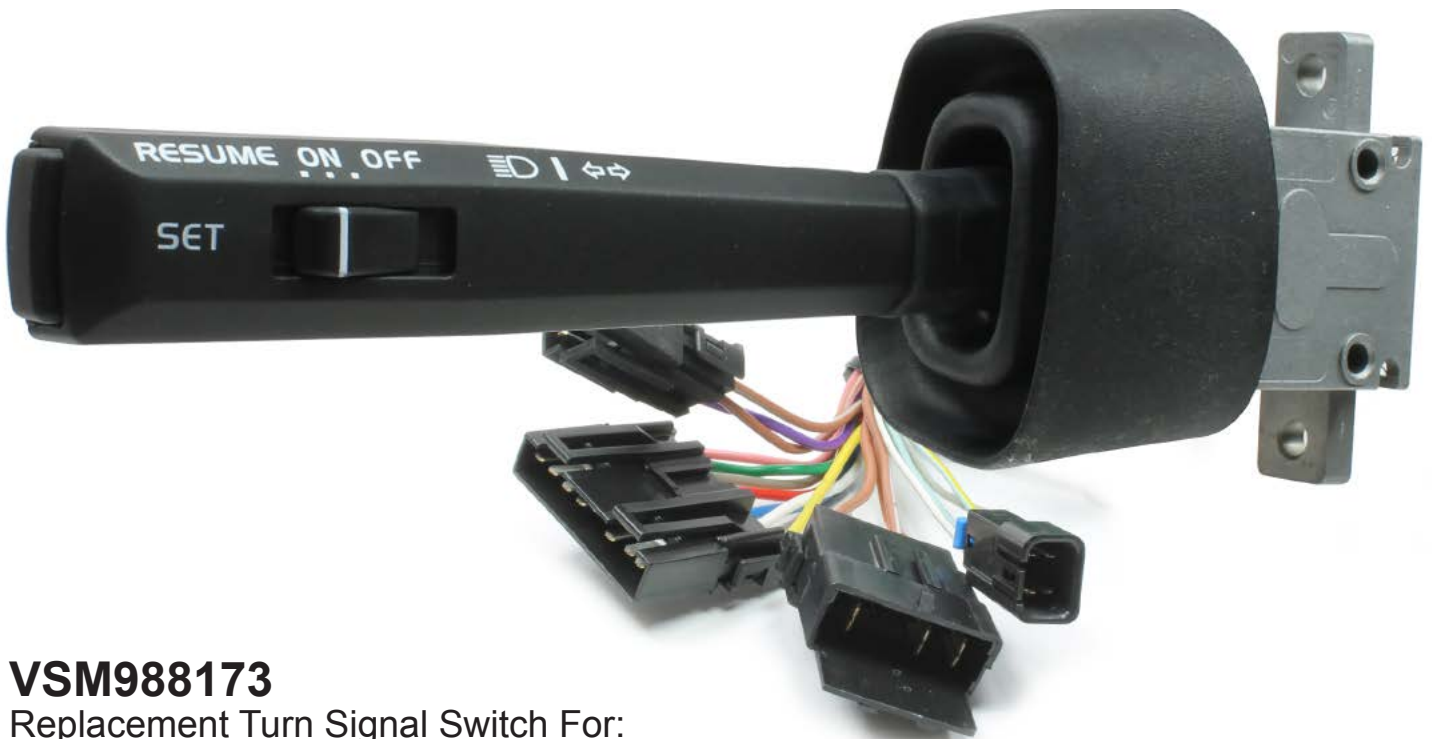

VSM988173
Replacement Turn Signal Switch For:
Volvo OEM REF # 3172173

MACK TRUCK



vsm999574
Replacement Turn Signal Switch for:
Mack 1MR574



vsm999575
Replacement Turn Signal Switch for:
Mack 1MR575



vsm900Y150
Replacement Turn Signal Switch for:
Mack 1MR3412; 1MR3412P2



vsm915Y703
Replacement Turn Signal Switch for:
Mack 1MR571



vsm900Y73
Replacement Turn Signal Switch for:
Mack 1MR2201P2; 1MR2201P1



vsm910Y601
Replacement Turn Signal Switch for:
Mack 1MR572



OEM Turn Signal Switches

OEM Turn Signal Switches

Palancas Direccionales Para Equipo Original

All turn signal switches 12V standard

VOLVO



vsm915Y117

Replacement Turn Signal Switch for:
VOLVO/GM 3081533, 84401-0020

- 8 wire harness
- Handle features built-in push button high/low beam selector switch
- 16 bulb capacity for hazard warning
- 8 bulbs per side for turn signal flashing



vsm915Y116

Replacement Turn Signal Switch for:
VOLVO/GM 3081534, 84401-3421

- 8 wire harness
- Handle features built-in push button high/low beam selector switch
- 16 bulb capacity for hazard warning
- 8 bulbs per side for turn signal flashing



vsm915Y105

Replacement Turn Signal Switch for:
VOLVO/GM 84401-3203

- 8 wire harness
- Handle features built-in push button high/low beam selector switch
- 16 bulb capacity for hazard warning
- 8 bulbs per side for turn signal flashing



vsm900Y129

Replacement Turn Signal Switch for:
VOLVO/GM 84401-0005

- Pilot light for turn signal & hazard warning
- 10 bulb capacity for hazard warning, 5 bulbs per side for turn signal flashing

OEM Turn Signal Switches



Palancas Direccionales Para Equipo Original

KENWORTH



vsm999295

Replacement Turn Signal Switch for:
KENWORTH K301-295-3



vsm999839

Replacement Turn Signal Switch for:
KENWORTH 480839H



vsm915Y704

Replacement Turn Signal Switch for:
KENWORTH K301-357

- Handle features built-in push button high/low beam selector switch



vsm915Y103

Replacement Turn Signal Switch for:
KENWORTH K301D230;18500D044

- 8 wire harness
- Handle features built-in push button high/low beam selector switch
- 16 bulb capacity for hazard warning
- 8 bulbs per side for turn signal flashing

All turn signal switches 12V standard



vsm999836

Replacement Turn Signal Switch for:
KENWORTH 480836E.



vsm900Y96

Replacement Turn Signal Switch for:
KENWORTH K-301-182

- Features pilot light for turn signal & hazard warning
- 6 wire harness



vsm900Y209

Replacement Turn Signal Switch for:
KENWORTH K301D182

- 10 bulb capacity for hazard warning
- 5 bulbs per side for turn signal flashing



OEM Turn Signal Switches

OEM Turn Signal Switches

Palancas Direccionales Para Equipo Original

All turn signal switches 12V standard

PETERBILT



vsm999827

Replacement Turn Signal Switch for:
PETERBILT 480827G



vsm915Y114

Replacement Turn Signal Switch for:
PETERBILT 16-04415

- 8 wire harness
- Handle features built-in push button high/low beam selector switch
- 16 bulb capacity for hazard warning
- 8 bulbs per side for turn signal flashing



vsm915Y121

Replacement Turn Signal Switch for:
PETERBILT 16-05713

- 18 wire harness
- Handle features built-in push button high/low beam selector switch



vsm915Y124

Replacement Turn Signal Switch for:
PETERBILT 16-06432

- 8 wire harness
- Handle features built-in push button high/low beam selector switch
- 16 bulb capacity for hazard warning
- 8 bulbs per side for signal flashing



vsm915Y104

Replacement Turn Signal Switch for:
PETERBILT 16-03827

- 17 wire harness
- Handle features built-in push button high/low beam selector switch
- 16 bulb capacity for hazard warning
- 8 bulbs per side for signal flashing

OEM Turn Signal Switches



Palancas Direccionales Para Equipo Original

All turn signal switches 12V standard

NAVISTAR



VSM999392

Replacement Turn Signal Switch For NAVISTAR 3544933C92



VSM915Y118

Replacement Turn Signal Switch For NAVISTAR 1616317C91

- Turn signal switch dimmer
- 8-wire harness
- Handle features push-button high/low beam selector
- 16 bulb capacity for hazard warning
- 8 bulbs per side for turn signal flashing



VSM900Y114

Replacement Turn Signal Switch For NAVISTAR 1663595C91; 775863C93; 523848C91

- 6-wire harness
- Pilot light for turn signal and hazard warning
- 10 bulb capacity for hazard warning
- 5 bulbs per side for turn signal flashing



VSM900Y206

Replacement Turn Signal Switch For NAVISTAR 1663595C91

- 6-wire harness
- 10 bulb capacity for hazard warning
- 5 bulbs per side for turn signal flashing



OEM Turn Signal Switches

OEM Turn Signal Switches

Palancas Direccionales Para Equipo Original

All turn signal switches 12V standard

WESTERN STAR



vsm918Y998
Replacement Turn Signal Switch for:
WESTERN STAR 84401-3431



vsm918Y994
Replacement Turn Signal Switch for:
WESTERN STAR 84401-3429



vsm918Y116
Replacement Turn Signal Switch for:
WESTERN STAR 84401-3421

UNIVERSAL



vsm999282
UNIVERSAL REPLACEMENT SWITCH
OEM Engineered Signal Switch for All Applications



vsm900
UNIVERSAL REPLACEMENT SWITCH
OEM Engineered Signal Switch for All Applications



vsm905
UNIVERSAL REPLACEMENT SWITCH
OEM Engineered for All Signal Switch Applications



vsm920
UNIVERSAL REPLACEMENT SWITCH

Golf Cart Applications

8-WIRE, HORN BUTTON FEATURE

- Popular replacement switch for golf carts
- Fits "NEV's" Neighborhood Electric Vehicle:
- Horn Push-Button Feature In Handle
- Die Cast Black Housing
- Heavy Duty Chrome Handle
- Heavy Duty Contacts and Wire

OEM Turn Signal Switches



Turn Signal Switches



VSM01480692



VSM01480693



VSM01480722



VSM01481177



VSM01481180



VSM01481184



VSM01481187



VSM01481190



VSM01481376



VSM01481382



VSM01481472



VSM01482878



VSM01482879



VSM01483074



VSM01483087



VSM01483096



VSM01483376



VSM01483377

Other Former Grote Switches Available From VSM

01444212	01482970	01483171	01484375
01444602	01482974	01483372	01484775
01481285	01483068	01483373	01484870
01481286	01483082	01483374	01484970
01481471	01483083	01484370	01484971
01481580	01483084	01484371	01485022
01482875	01483088	01484372	01489972
01482876	01483089	01484374	01489977

Destelladores & Reles



VSM128



VSM129

VSM129 Heavy Duty ISO Base Relay (12 Volt)
30 amp OEM relay designed for turn signal switches, headlight dimming. Also applies to horn, fog light, radio kill switch, clearance or marker light flasher

VSM128 Same As VSM129 Except With Tab



VSM254



VSM255

VSM254 2-Pin Flasher
Flasher 12 Volt, 2-Pin, 20 Lamp, 45 Amp

VSM255 2-Pin Electronic Flasher
3-Pin, 20 Lamp, 45 Amp Electronic Flasher



VSM262



VSM263

VSM262 12 Lamp Electronic Flasher
2-Pin, 12 Lamp, Electronic Flasher

VSM263 12 Lamp Electronic Flasher
3-Pin, 12 Lamp, Electronic Flasher



VSM557



VSM558

VSM557 2-Pin Electronic Flasher
2-Pin, 10 Lamp Heavy Duty Electronic Flasher

VSM558 3-Pin Electronic Flasher
3-Pin, 10 Lamp Heavy Duty Electronic Flasher



VSM285



VSM287

VSM285 2-Pin LED Solid State Flasher (with ground wire)

VSM287 3-Pin LED Solid State Flasher (with ground wire)

- Lamp Rating: .10 to 25 amp
 - Rated Voltage: 11 to 15 volts DC
 - Flash Rate: 60 to 120 flashes per minute
- Meet Or Exceed DOT And SAE Specifications.

Operates From 1 Milliamps Up To 6 Amps - Allowing The Use Of Two Incandescent Signal Lamps With Led Stop, Tail, Turn Signal Lamps (i.e. VSM6164A Side Turn Signals Can Be Used In Conjunction With VSM4464 LED Lamps).



VSM9183 Universal Flasher/Bulb Connector

- For Use With Plug In Flashers Or Sealed Beams
- Nylon Housing
- 7" Color Coded Wire Leads With 16 Gauge Wire
- Without Fuse-In-Line
- For 12 Volt Or 24 Volt Applications



VSM9185 Relay Connector

- Nylon Housing
- With 12" 14 Gauge Wire
- For 12 Volt Or 24 Volt Applications



VSM9187 Universal Flasher Connector

- Design Provides For 2 Or 3-Pin Flasher
- Includes 15 Amp Blade Type Fuse
- Ring Terminal On Lead Wire
- 12 Volt Or 24 Volt Applications

Volvo Sunvisor LED Marker Light



VSM1365A
Volvo 20414610



VSM1365AK
Volvo 85107907



VSM1365AC
Volvo 21882502



New Product: Volvo Sunvisor LED Marker Lights



Heavy-Duty Lighting Plan-O-Gram

Vehicle Safety Manufacturing is excited to announce the availability of the company's first free-standing retail plan-o-gram display. Standing six feet tall, this rolling three-sided display is comprised of VSM's most popular LED and incandescent lighting and repair harness products.

How Does The Plan-O-Gram Program Work?

VSM customers will receive one display rack at no cost that will be assembled by a regional sales manager when purchasing the attached inventory list:

Panel A

1st Row				
4464D	4464AD	4464WD	4440D	
2nd Row				
6464D	6464AD	6464WD	6440D	
3rd Row				
3305D	3305AD	3305BD	3305WD	3305GD
4th Row				
1015D	1015AD	1505D	1505AD	1505WD
5th Row				
1035D	1035AD	1905D	1905AD	1255D 1255AD

Panel B

1st Row				
7562D	4064D	4064AD	4064WD	
2nd Row				
1900D	1900AD	6064D	6064AD	6064WD
3rd Row				
1010D	1010AD	1011D	1011AD	1030D 1030AD
4th Row				
5551DK	1500D	1500AD	1500WD	
5th Row				
2264AD	9124D	9122D	9128D	6564AD
6th Row				
9526D	9127D	9119D	9139D	

Panel C

1st Row				
4454D	4454AD	44544D	44544AD	
2nd Row				
4054D	4054AD	4054CD	2105KD	2105AKD
3rd Row				
6054D	6054AD	6054CD	6454D	6454AD
4th Row				
1010KD	1010AKD	1015KD	1015AKD	1011KD 1011AKD
5th Row				
1035KD	1035AKD	6154AD	6554AD	



All panels available individually for wall mounting or with triangular base as free-standing display.

VSM Retail Plan-O-Gram Floor and Wall Display

7" LED Strobe/Warning Lamps



7" red or amber flash and strobe warning lamps. Industry-standard mounting bolt patterns and three-wire connections (power/ground/strobe) provide for easy retrofitting while die-cast aluminum housings protect against corrosion and build-up of heat within the lamp assembly. Instant-on, ultra-bright LEDs mean immediate visibility at great distances during daytime and low-light conditions ensuring maximum school bus safety.

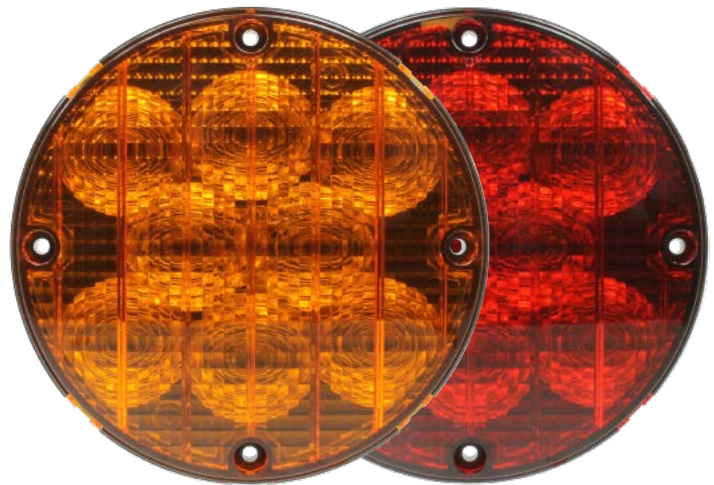

VSM6557A

VSM6557

Product Features

Meets FMVSS 108 and SAE J887 requirements.
Includes Steady Flash & Strobing Flash functions.
Eight 3-Watt surface-mount LEDs.
Thin profile reduces risk of impact damage.
Sealed construction (IP67/IP69K).

Red or Amber polycarbonate lens.
Die-cast aluminum housing.
Surface-mount design eliminates large cut-out.
Industry standard mounting bolt pattern.

Product Photos



New Product: 7" LED Strobe/Warning Lamps



7" LED Stop/Tail/Turn/Backup and Warning Lamps

7" LED Surface-Mount Backup Lamp

7" Clear Backup Lamp - VSM6553W

24 SMD LED

Black Polycarbonate Housing

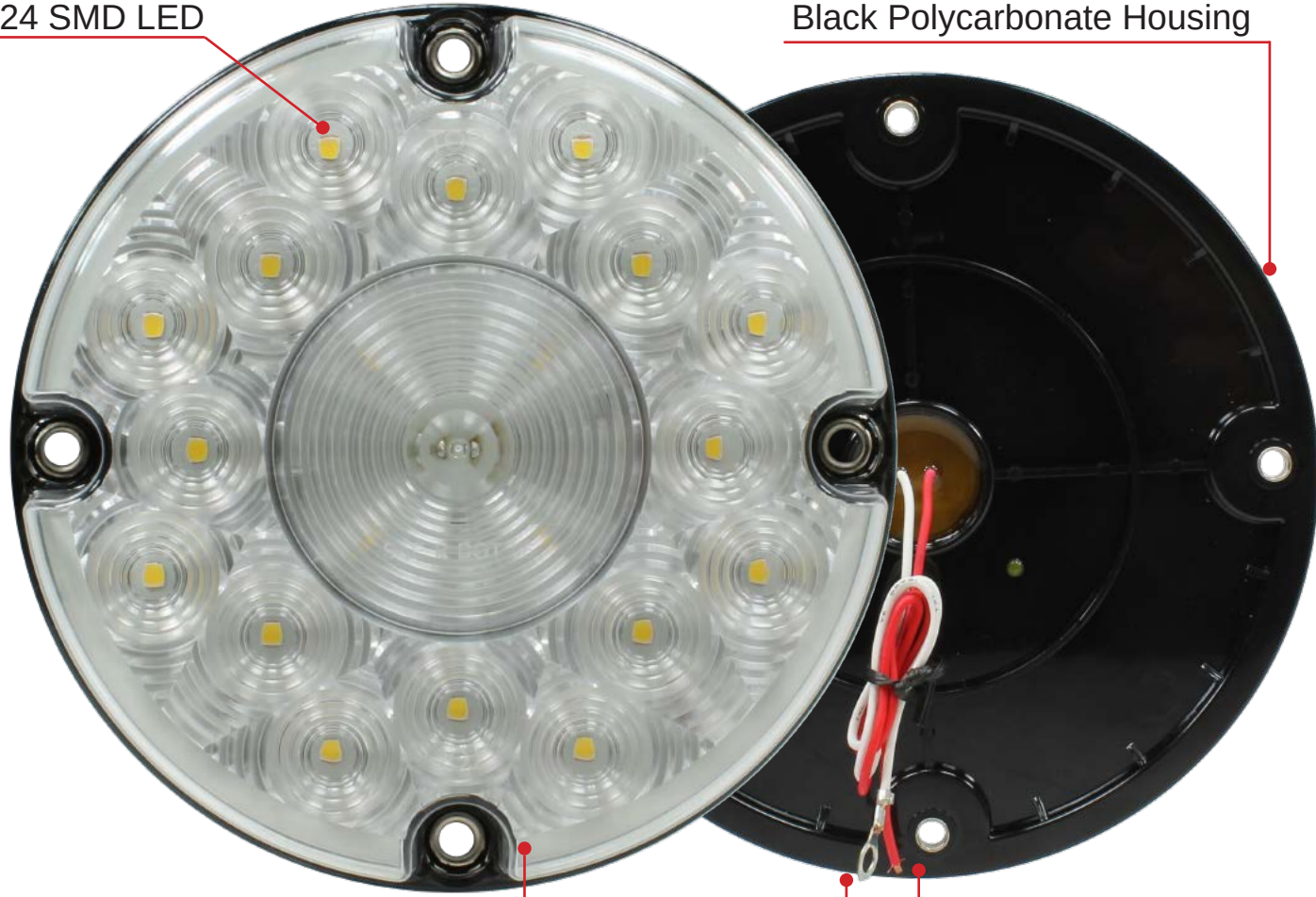

Clear Optic Polycarbonate Lens

Eyelet Reinforced Mount

18 AWG TXL Wires 2-wire Connection

- Operating Voltage 9 – 16 VDC
- Design Voltage 12.8 VDC / .160 Amp
- FMVSS (R)
- Venting Membrane Eliminates Condensation and Improves Thermal Management

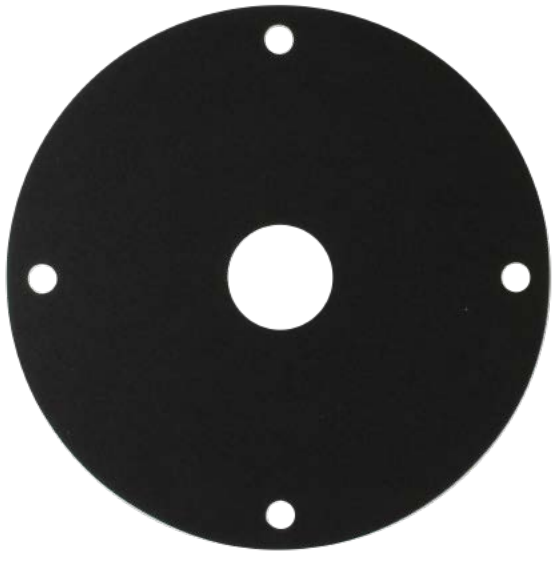

Mounting Gasket Included

Gore™ Breather Built-In

7" LED Stop/Tail/Turn/Backup and Warning Lamps



Vehicle Safety Manufacturing is pleased to introduce its all-new **VSM6553A** and **VSM6556** 7" red or amber LED stop/tail/turn signal lamps. Industry-standard mounting bolt patterns and two- and three-wire connections provide for easy retrofitting while sealed housings protect against corrosion. Instant-on, ultra-bright LEDs mean immediate visibility at great distances during daytime and low-light conditions ensuring maximum vehicle safety.



Product Features

Low amp current draw.
All plastic construction.

Reflex Lens *

Optic Lens **

Double contact 3-wire connection *

Industry standard bolt pattern.

Includes foam mounting gasket.

Meets FMVSS 108 federal specification.

IP67 waterproof rated.

Single contact 2-wire connection **

* applies to VSM6556

** applies to VSM6553A



GORE™ Breather Built-In



Single and Dual-Diode

Clearance/Marker Lamps by VSM

Single-Diode Lamps with Superflux LED

Single and Dual Diode S/T/T and Clearance/Marker Lamps



10151A
(2.5" Sealed C/M - Amber)

10151
(2.5" Sealed C/M - Red)

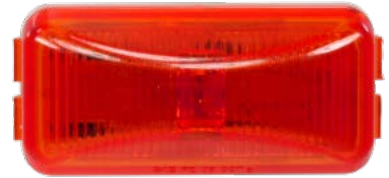

10351A
(2" Sealed)

10351
(2" Sealed)

15051A (2.5" Rectangular) **15051** (2.5" Rectangular)

Voltage/Amp: **13.5V / 0.045~0.05A; 0.050~0.055A** Lens: **PMMA (Amber or Red)**

SAE Specs: **SAE J592e, SAE J578, SAE J575e** Housing: **ABS Plastic**

Dual-Diode Lamps with Superflux LED



19052A (3 7/8" Rectangular Sealed C/M)

19052 (3 7/8" Rectangular Sealed C/M)

Voltage/Amp: **13.5V / 0.050~0.055A**

Specification: **SAE J592e, SAE J578, SAE J575e**

Lens: **Polycarbonate (Amber or Red)**

Housing: **Polycarbonate**

Single and Dual-Diode



Clearance/Marker Lamps by VSM

Single-Diode Lamps with Superflux LED

Single and Dual Diode S/T/T and Clearance/Marker Lamps



44641A (4" Sealed Turn Signal Lamp - Amber)



44641 (4" Sealed S/T/T Lamp - Red)



64641A
(6" Sealed Turn Signal Lamp - Amber)



64641
(6" Sealed S/T/T Lamp - Red)

Voltage/Amp: **13.5V / 0.245~0.255A; 0.008~0.010A**
SAE Specs: **SAE J588, SAE J578, SAE J575e, SAE J222 ***

Lens: **PMMA (Amber or Red)**
Housing: **ABS Plastic**

* Applies to 64641A and 64641 only



High Count/Multi-Diode

All Lamps 12-Volt Standard - Red Lens Standard

Multi Diode

Stop/Tail/Turn LED Lamps



6464AX



6" Oval Sealed S/T/T Signal Lamps (Grommet Mount)

- VSM6464AX Amber 52 Diode Turn Signal Lamp
- VSM6464X Red 52 Diode S/T/T Lamp



6468X

6468AX

6" Oval Sealed S/T/T Signal Lamps (Welded Flange Mount)

- VSM6468AX Amber 52 Diode Turn Signal Lamp
- VSM6468X Red 52 Diode S/T/T Lamp

High Count/Multi-Diode LED Lamps

High Count/Multi-Diode



Multi Diodo

High Count/Multi-Diode LED Lamps

All Lamps 12-Volt Standard - Red Lens Standard

LED Clearance/Marker Lamps

Features

- Sonically Welded High-Impact Polycarbonate Lens And Housing.
- Electronics Totally Sealed In Epoxy Resin For Complete Moisture, Corrosion And Vibration Protection.
- Uses Standard Industry Grommets And Pigtail Connection.

2.5" Round Sealed Clearance/Marker Lamps

- VSM1015AX** Amber 13 Diode Clearance/Marker Lamp
VSM1015X Red 13 Diode Clearance/Marker Lamp
VSM1015ACX Amber 13 Diode With Clear Lens Clearance/Marker Lamp
VSM1015RCX Red 13 Diode With Clear Lens Clearance/Marker Lamp



VSM1015X

VSM1015AX

VSM1015ACX ●

VSM1015RCX ●

Rear View

Replacement Parts: Mounting Grommet **VSM9119** Pigtail **VSM9122**

2" Round Sealed Clearance/Marker Lamps

- VSM1035AX** Amber 10 Diode Clearance/Marker Lamp
VSM1035X Red 10 Diode Clearance/Marker Lamp
VSM1035ACX Amber 10 Diode With Clear Lens Clearance/Marker Lamp
VSM1035RCX Red 10 Diode With Clear Lens Clearance/Marker Lamp



VSM1035X

VSM1035AX

VSM1035ACX ●

VSM1035RCX ●

Rear View

Replacement Parts: Mounting Grommet **VSM9139** Pigtail **VSM9122**

2.5" 1500 Series Sealed Clearance/Marker Lamps

Mounts To Industry Standard Brackets

- VSM1505AX** Amber 8 Diode Clearance/Marker Lamp
VSM1505X Red 8 Diode Clearance/Marker Lamp



VSM1505X

VSM1505AX

Rear View

Replacement Parts: Pigtail **VSM9122**



High Count/Multi-Diode

All Lamps 12-Volt Standard - Red Lens Standard

Multi Diode

LED Clearance/Marker Lamps Continued...

4" 1900 Series Sealed Clearance/Marker Lamps

Mounts To Industry Standard Brackets

VSM1905AX Amber 12 Diode Clearance/Marker Lamp

VSM1905X Red 12 Diode Clearance/Marker Lamp



VSM1905AX



VSM1905X

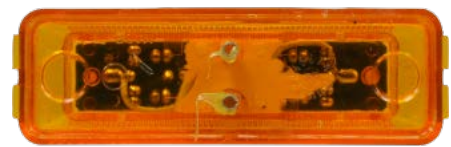

Rear View

Replacement Parts: Pigtail **VSM9122**

Double Bulls Eye Clearance/Marker Lamps

Industry Standard Connections

VSM1255AX Amber 16 Diode Double Bulls Eye Clearance/Marker Lamp

VSM1255X Red 16 Diode Double Bulls Eye Clearance/Marker Lamp



VSM1255AX



VSM1255X



Rear View

LED Stop/Tail/Turn Lamps 4400 Series

VSM4440

Low Profile 4" Stop/Tail/Turn Lamp



VSM4468RF

Flush-Mount 4" Stop/Tail/Turn Signal Lamp



- 10 diode LED Low Profile Housing.
- Sonically Sealed Housing and Lens.
- Sure Seal Connection.
- Only 1.5" Thick.



VSM9427
Standard Harness to
Sure Seal Plug
Sold Separately



- Flange Meets Legal Class A Reflector Requirements.
 - Flush-Mount Design Protects Lamp Assembly.
 - Sonically Sealed Lens/Housing
 - Red PMMA Lens, White ABS Housing
 - Black ABS Bezel
 - Three-Hole Mounting Pattern.
- SAE J1398, SAE J585e, SAE J592e, SAE J594f

High Count/Multi-Diode LED Lamps

LED Stop/Tail/Turn Lamps



LED Stop/Tail/Turn Lamps

All Lamps 12-Volt Standard

Lamparas LED de Freno/Traseras/Direccionales

LED Stop/Tail/Turn Lamps 4400 Series Continued...

4" Round Sealed LED Stop/Tail/Turn Lamps

- VSM4464A** Amber 10 Diode Auxiliary Signal Lamp
- VSM4464** Red 10 Diode Stop/Tail/Turn Lamp
- VSM4464AC** Amber 10 Diode Auxiliary Signal Lamp With Clear Lens
- VSM4464RC** Red 10 Diode Stop/Tail/Turn Lamp With Clear Lens



VSM4464A

VSM4464

VSM4464AC ●

VSM4464RC ●

Rear View

4" Round Sealed LED Stop/Tail/Turn Lamp Kits (Rubber Grommet)

- VSM4454A** Amber 10 Diode Auxiliary Signal Lamp Kit
- VSM4454** Red 10 Diode Stop/Tail/Turn Lamp Kit
- VSM4454AC** Amber 10 Diode Auxiliary Signal Lamp Kit With Clear Lens
- VSM4454RC** Red 10 Diode Stop/Tail/Turn Lamp Kit With Clear Lens



VSM4454A

VSM4454

VSM4454AC ●

VSM4454RC ●

Replacement Parts: Grommet **VSM9127** Pigtail **VSM9124** Pigtail **VSM9128** (Right Angle)

4" Round Sealed High Count LED Stop/Tail/Turn Lamps

- VSM44544A** Amber 24 Diode Auxiliary Signal Lamp Kit
- VSM44544** Red 24 Diode Stop/Tail/Turn Lamp Kit
- VSM44644A** Amber 24 Diode Auxiliary Signal Lamp
- VSM44644** Red 24 Diode Stop/Tail/Turn Lamp



VSM44544A

VSM44544

VSM44644A

VSM44644



LED Stop/Tail/Turn Lamps

All Lamps 12-Volt Standard

Lamparas LED de Freno/Traseras/Direccionales

LED Stop/Tail/Turn Lamps 4400 Series Continued...

4" Round Sealed LED Stop/Tail/Turn Lamp Kits (Grey Flange)

- VSM4457A** Amber 10 Diode Auxiliary Signal Lamp Kit
- VSM4457** Red 10 Diode Stop/Tail/Turn Lamp Kit
- VSM4457AC** Amber 10 Diode Auxiliary Signal Lamp Kit With Clear Lens
- VSM4457RC** Red 10 Diode Stop/Tail/Turn Lamp Kit With Clear Lens



VSM4457A



VSM4457



VSM4457AC ●



VSM4457RC ●

4" Round Sealed LED Stop/Tail/Turn Lamp Kits (Black Flange)

- VSM4458A** Amber 10 Diode Auxiliary Signal Lamp Kit
- VSM4458** Red 10 Diode Stop/Tail/Turn Lamp Kit
- VSM4458AC** Amber 10 Diode Auxiliary Signal Lamp Kit With Clear Lens
- VSM4458RC** Red 10 Diode Stop/Tail/Turn Lamp Kit With Clear Lens



VSM4458A



VSM4458



VSM4458AC ●



VSM4458RC ●

4" Round Sealed LED Stop/Tail/Turn Lamp Kits (Chrome Flange)

- VSM4459A** Amber 10 Diode Auxiliary Signal Lamp Kit
- VSM4459** Red 10 Diode Stop/Tail/Turn Lamp Kit
- VSM4459AC** Amber 10 Diode Auxiliary Signal Lamp Kit With Clear Lens
- VSM4459RC** Red 10 Diode Stop/Tail/Turn Lamp Kit With Clear Lens



VSM4459A



VSM4459



VSM4459AC ●



VSM4459RC ●

LED Stop/Tail/Turn Lamps

LED Stop/Tail/Turn Lamps



All Lamps 12-Volt Standard

Lamparas LED de Freno/Traseras/Direccionales

LED Stop/Tail/Turn Lamps 6400 Series

6" Oval Sealed LED Stop/Tail/Turn Lamp Kit (Rubber Grommet)

- VSM6454A** Amber 10 Diode Auxiliary Signal Lamp Kit
- VSM6454** Red 10 Diode Stop/Tail/Turn Lamp Kit
- VSM6454AC** Amber 10 Diode Auxiliary Signal Lamp Kit With Clear Lens
- VSM6454RC** Red 10 Diode Stop/Tail/Turn Lamp Kit With Clear Lens



VSM6454A



VSM6454



VSM6454AC ●



VSM6454RC ●

Replacement Parts: Grommet **VSM9526** Pigtail **VSM9124**

6" Oval Sealed LED Stop/Tail/Turn Lamp

- VSM6464A** Amber 10 Diode Auxiliary Signal Lamp
- VSM6464** Red 10 Diode Stop/Tail/Turn Lamp
- VSM6464AC** Amber 10 Diode Auxiliary Signal Lamp With Clear Lens
- VSM6464RC** Red 10 Diode Stop/Tail/Turn Lamp With Clear Lens



VSM6464A

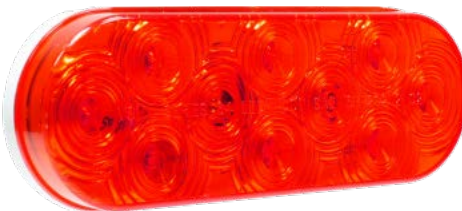

VSM6464



VSM6464AC / VSM6464RC



LED Stop/Tail/Turn Lamps

All Lamps 12-Volt Standard

Lamparas LED de Freno/Traseras/Direccionales

LED Stop/Tail/Turn Lamps 6400 Series Continued...

6" Oval Sealed LED Stop/Tail/Turn Lamp Kit (Rubber Grommet)

VSM6466 Red 10 Diode Stop/Tail/Turn Lamp Kit

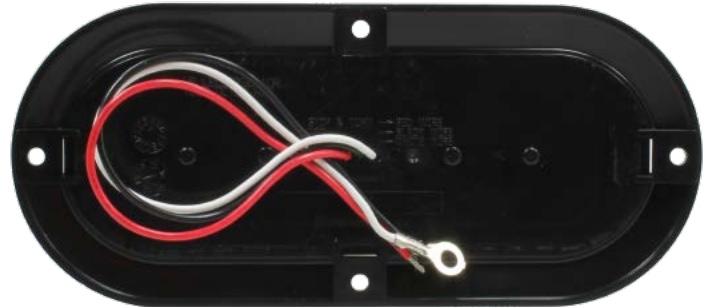

Rear View

Features

- Surface Mount Unit Does Not Require Panel Cutout
- Super Flux 10 LED - Light Emitting Diodes
- Designed At 13.5V 0.21/0.1 Amp
- Sonically Sealed Polycarbonate Housing And Lens
- Hard Wired With 3 Lead Wires

VSM6456 VSM6466 Lamp with Chrome Bezel

VSM9866 Chrome Bezel for VSM6466 Lamp



LED Stop/Tail/Turn Lamps

6" Oval Sealed LED Stop/Tail/Turn Lamp Kits (Grey Flange)

VSM6457A Amber 10 Diode Auxiliary Signal Lamp Kit

VSM6457 Red 10 Diode Stop/Tail/Turn Lamp Kit

VSM6457W Clear 10 Diode Utility Lamp Kit



VSM6457A



VSM6457



VSM6457W

Replacement Parts: Pigtail **VSM9124**

6" Oval Sealed LED Stop/Tail/Turn Lamp (Grey Flange)

VSM6467A Amber 10 Diode Auxiliary Signal Lamp

VSM6467 Red 10 Diode Stop/Tail/Turn Lamp

VSM6467W Clear 10 Diode Utility Lamp

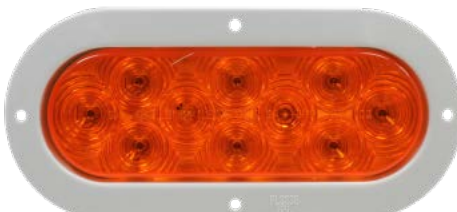

VSM6467A



VSM6467



VSM6467W

LED Stop/Tail/Turn Lamps



All Lamps 12-Volt Standard

Lamparas LED de Freno/Traseras/Direccionales

LED Stop/Tail/Turn Lamps 6400 Series Continued...

6" Oval Sealed LED Stop/Tail/Turn Lamp Kits (Black Flange)

- VSM6458A** Amber 10 Diode Auxiliary Signal Lamp Kit
- VSM6458** Red 10 Diode Stop/Tail/Turn Lamp Kit
- VSM6458W** Clear 10 Diode Utility Lamp Kit



VSM6458A



VSM6458



VSM6458W

6" Oval Sealed LED Stop/Tail/Turn Lamp (Black Flange)

- VSM6468A** Amber 10 Diode Auxiliary Signal Lamp
- VSM6468** Red 10 Diode Stop/Tail/Turn Lamp
- VSM6468W** Clear 10 Diode Utility Lamp



VSM6468A



VSM6468



VSM6468W

6" Oval Sealed LED Stop/Tail/Turn Lamp Kits (Chrome Flange)

- VSM6459A** Amber 10 Diode Auxiliary Signal Lamp Kit
- VSM6459** Red 10 Diode Stop/Tail/Turn Lamp Kit
- VSM6459W** Clear 10 Diode Utility Lamp Kit



VSM6459A



VSM6459



VSM6459W

6" Oval Sealed LED Stop/Tail/Turn Lamp Kits (Chrome Flange)

- VSM6469A** Amber 10 Diode Auxiliary Signal Lamp
- VSM6469** Red 10 Diode Stop/Tail/Turn Lamp
- VSM6469W** Clear 10 Diode Utility Lamp





LED Stop/Tail/Turn Lamps

All Lamps 12-Volt Standard

Lamparas LED de Freno/Traseras/Direccionales

24-Diode Sealed LED Stop/Tail/Turn Lamps

Rectangular 4500 Series Lamps

- VSM45644A** Amber Park/Turn Lamp
- VSM45644** Red Stop/Tail/Turn Lamp

Features

- 24 Diodes Pattern Design With Interior Chrome Reflector.
- Unique Optics Design Displays A Full Pattern Of Light.
- Sonically Sealed Waterproof Construction.
- Polycarbonate Lens And Housing.
- Epoxy Encapsulated Electronics.
- Suitable For Horizontal Or Vertical Orientation.
- Uses Standard PL-3 Connection.
- Designed @ 13.5Volts, .380/.030 Amp.

Replacement Parts

- Rubber Grommet **VSM9175** Steel Bracket **VSM9287**
- Right Angle Pigtail **VSM9128** Pigtail **VSM9124**



VSM45644A

VSM45644

4" Round 4400 Series Lamps

- VSM44644A** Amber Park/Turn Lamp
- VSM44644** Red Stop/Tail/Turn Lamp
- VSM44634W** Backup Lamp

Features

- 24 Diodes Pattern Design With Interior Chrome Reflector.
- Unique Optics Design Displays A Full Pattern Of Light.
- Sonically Sealed Waterproof Construction.
- Epoxy Encapsulated Electronics.
- Uses Standard PL-3 Connection.



Replacement Parts Rubber Grommet **VSM9127** Pigtail **VSM9124** 90-Degree Pigtail **VSM9128**

6" Oval 6400 Series Lamps

- VSM64644A** Amber Park/Turn Lamp
- VSM64644** Red Stop/Tail/Turn Lamp
- VSM64644AC** Amber Park/Turn Lamp, Clear Lens ●
- VSM64634W** Backup Lamp

Features

- 24 Diodes Pattern Design With Interior Chrome Reflector.
- Unique Optics Design Displays A Full Pattern Of Light.
- Sonically Sealed Waterproof Construction.
- Epoxy Encapsulated Electronics.
- Uses Standard PL-3 Connection.

Replacement Parts

- Rubber Grommet **VSM9526** Steel Bracket **VSM9525**
- Right Angle Pigtail **VSM9128** Pigtail **VSM9124**



LED Stop/Tail/Turn Lamps

6400-Series Sealed Lamps in Stainless Steel Panels

Features:

10-Diode VSM6400-Series LED Lamps Mounted in Hi-Polished HD Corrosion-Resistant Stainless Steel Panel. Includes Rubber Mounting Grommet and Custom Daisy-Chain Harness System.

Singled LED Oval Lamp in 8.25-Inch Stainless Steel Mount

• Includes VSM9526 Grommet and VSM9128 Right Angle Plug Harness

- VSM6491** Red 6464 Lamp in Single-Hole Bracket
- VSM6491A** Amber 6464A Lamp in Single-Hole Bracket
- VSM9525** Black Powder Coated Steel Oval Single-Hole Bracket Only
- VSM9526** Oval Rubber Grommet



Two LED Oval Lamps in 16.5 inch Stainless Steel Mount

• Includes 9526 Grommets & 91282 Right Angle 2-Plug String Harness

- vsm6492** Two Red 6464 Lamps in 2-Hole Bracket
- vsm6492A** Two Amber 6464A Lamps in 2-Hole Bracket

- vsm91282** Molded Right Angle 2-Plug String Harness
- vsm9526** Oval Grommet



Three Sealed Oval Lamps in 25 inch Stainless Steel Mount

• Includes 9526 Grommets & 91283 Right Angle 3-Plug String Harness

- vsm6493** Three Red 6464 Lamps in 3-Hole Bracket
- vsm6493A** Three Amber 6464A Lamps in 3-Hole Bracket

- vsm91283** Molded Right Angle 3-Plug String Harness
- vsm9526** Oval Grommet



Four LED Oval Lamps In 33-Inch Stainless Steel Mount

• Includes 9526 Grommets and 91284 Right Angle 4-Plug String Harness

- VSM6494** Four Red 6464 Lamps in 4-Hole Bracket
- VSM6494A** Four Amber 6464A Lamps in 4-Hole Bracket
- VSM6494RC** Four Clear Lens Red 6464RC Lamps in 4-Hole Bracket
- VSM6494AC** Four Clear Lens Amber 6464AC Lamps in 4-Hole Bracket
- VSM91284** Molded Right Angle 4-Plug String Harness
- VSM9526** Oval Grommet





LED Clearance/Marker Lamps

All Lamps 12-Volt Standard - Red Lens Standard

Lamparas Led para Despeje/Marcadoras

1015 Series Clearance/Marker Lamps 2.5 Inch Sealed LED Clearance/Marker Lamps

Features

- Operates in Both Polarities
- Polycarbonate Housing and Lens
- Sonically welded lens and base
- Protective Encapsulation of Electronic
- Designed at 14 Volt, .060 Amps

Pair VSM's 1015-series clearance/marker lamps with grommet/pigtail kit **VSM9219** for a quick install.



Encapsulated Diodes

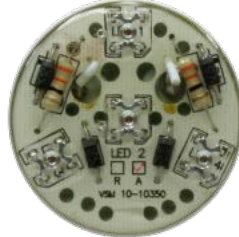

Four LED configuration assures optimal lighting performance and cost effectiveness.

Standard Connections



VSM's 1015 Series LED 2.5" lamps have industry standard connections.

Polycarbonate Lens/Housing



A sealed polycarbonate housing provides added protection against the elements.



1015 Series Round 2.5" Clearance/Marker Lamp Kits

- VSM1015AK** Amber Clearance/Marker Lamp Kit
- VSM1015K** Red Clearance/Marker Lamp Kit
- VSM1025AK** Amber Clearance/Marker Lamp Kit, Reflex Lens
- VSM1025K** Red Clearance/Marker Lamp Kit, Reflex Lens



1015 Series Round 2.5" Clearance/Marker Lamps

- VSM1015A** Amber Clearance/Marker Lamp
- VSM1015** Red Clearance/Marker Lamp
- VSM1015ACX** 13-Diode Amber Clearance/Marker Lamp
- VSM1015RCX** 13-Diode Red Clearance/Marker Lamp
- VSM1025A** Amber Clearance/Marker Lamp, Reflex Lens
- VSM1025** Red Clearance/Marker Lamp, Reflex Lens



1015 Series Flush-Mount Flange Lamps (Grey Flange)

Plastic flange protects lamp against damage and theft

- VSM1015AF** VSM1015A Lamp, Grey Flush Mount
- VSM1015F** VSM1015 Lamp, Grey Flush Mount



1015 Series Surface-Mount Flange Lamps (Grey Flange)

- VSM1015ASF** VSM1015A Lamp, Grey Surface Mount
- VSM1015SF** VSM1015 Lamp, Grey Surface Mount

LED Clearance/Marker Lamps

LED Clearance/Marker Lamps



All Lamps 12-Volt Standard - Red Lens Standard

Lamparas Led para Despeje/Marcadoras

LED Clearance/Marker Lamps

The 1035 Series LED lamps are available with clear lenses. For Red LED order part number and add suffix "RC" (e.g.1035RC)
For Amber LED order part number and add "C" suffix (e.g.1035AC)

1035 SERIES 2 Inch Sealed LED Clearance/Markers

Features:

- Designed at 14 Volt, .060 Amps
- Operates in Both Polarities
- Polycarbonate Housing and Lens
- Sonically welded lens and base for water-tight construction
- Protective Encapsulation of Electronic



Encapsulated Diodes
Four LED configuration assures optimal lighting performance and cost effectiveness.



Standard Connections
VSM's 1035 Series LED 2" lamps have industry standard connections

1035 Series 2" Round Sealed Clearance/Marker Lamps

- VSM1035A** Amber LED Clearance Side Marker
- VSM1035** Red LED Clearance Side Marker
- VSM1035ACX** 10-Diode Amber LED Side Marker
- VSM1035RCX** 10-Diode Red LED Side Marker

FLANGE MOUNT LAMPS

Flush Mount

Plastic flange protects lamp against damage and theft

vsm1035F

1035 Red LED lamp with gray polycarbonate flush mount flange

vsm1035AF

1035A Amber LED lamp with gray polycarbonate flush mount flange



Surface Mount

vsm1035SF

1035 Red LED lamp with gray polycarbonate surface mount flange

vsm1035ASF

1035A Amber LED lamp with gray polycarbonate surface mount flange

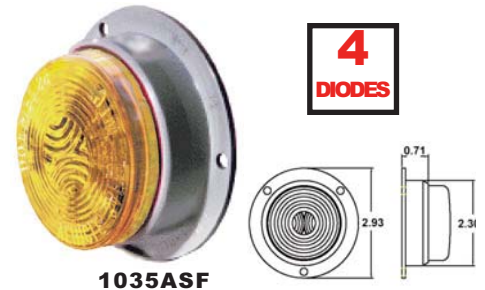

LAMP KITS

Kits include 1035 Series Lamp and vsm9239 Rubber Grommet/Pigtail Kit

vsm1035K 1035 Red LED lamp with Grommet and Pigtail

vsm1035AK 1035A Amber LED lamp with Grommet and Pigtail

vsm9239 2" Grommet & Pigtail Kit

Consists of vsm9139 Rubber Grommet and vsm9122 Pigtail





LED Clearance/Marker Lamps

LED Clearance/Marker Lamps

Led de Despeje/Marcadoras

All Lamps 12 V Standard • Red Lens Standard

The 1905 Series LED lamps are available with clear lenses. For Red LED order part number and add suffix "RC" (e.g.1905RC)
For Amber LED order part number and add "C" suffix (e.g.1905AC)

1905 SERIES

3.87 inch Sealed Rectangular LED Clearance / Marker Lamps

Features:

- Designed at 14 Volt, .060 Amps
- Operates in Both Polarities
- Polycarbonate Housing and Lens
- Sealed Water Tight Construction
- Protective Encapsulation of Electronics



Encapsulated Diodes

The 1905 Series lamps have four (red) or four (amber) completely sealed LED configurations. Assures optimal lighting performance and cost effectiveness.

1905 SERIES SEALED RECTANGULAR LED LAMPS

3.87" L x 1.2" W x .80" D

vsm1905 Red rectangular sealed LED lamp

vsm1905A Amber rectangular sealed LED lamp



STANDARD CONNECTIONS

The 1905 Series lamps have industry standard connections and pin-out.

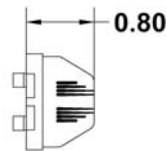
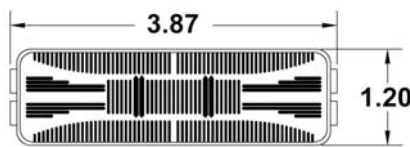

1905 SERIES LED LAMP KITS

Kits consist of 1905 series lamp, surface mounting bracket and a hot wire.

vsm1989K Red Rectangular Lamp with Surface Mount Bracket and Hot Wire Kit

vsm1989AK Amber Rectangular Lamp with Surface Mount Bracket and Hot Wire Kit

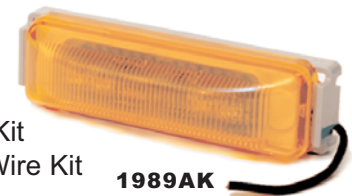

1905 Series Base Mount Kit & Assembly

vsm9389 Gray ABS Surface Mount Bracket with Hot Wire Kit

vsm9256 Hot Wire for 1905 Series lamps

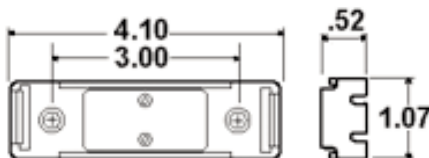

The 1505 Series LED lamps are available with clear lenses. For Red LED order part number and add suffix "RC" (e.g.1505RC)
For Amber LED order part number and add "C" suffix (e.g.1505AC)

1505 SERIES

2.5 inch Sealed Rectangular LED Clearance / Marker Lamps

Features:

- Designed at 14 Volt, .060 Amps
- Operates in Both Polarities
- Polycarbonate Housing and Lens
- Sealed Water Tight Construction
- Protective Encapsulation of Electronics



Encapsulated Diodes

The 1505 Series lamps have two (red) or three (amber) completely sealed LED configurations. Assures optimal lighting performance and cost effectiveness.

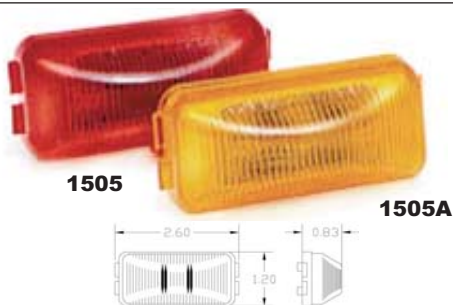

1505 SERIES SEALED RECTANGULAR LED LAMPS

2.5" L x 1.2" W x .830" D

vsm1505 Red rectangular sealed LED lamp

vsm1505A Amber rectangular sealed LED lamp

vsm1505W White rectangular sealed LED lamp



Standard Connections

The 1505 Series lamps have industry standard connections and pin-out.

1505 SERIES LAMP KITS

1505 Series LED Sealed Lamp, Bracket and Pigtail or Hot Wire

vsm1581K Red Lamp with 9381 ABS Chrome Bracket and 9122 Pigtail

vsm1581AK Amber Lamp with 9381 ABS Chrome Bracket and 9122 Pigtail

vsm1587K Red Lamp with 9387 ABS Header Mount and 9122 Pigtail

vsm1587AK Amber Lamp with 9387 ABS Header Mount and 9122 Pigtail

vsm1593K Red Lamp with 9393 ABS Branch Deflector Bracket and Hot Wire

vsm1593AK Amber Lamp with 9393 ABS Branch Deflector Bracket and Hot Wire



SURFACE MOUNT BRACKETS FOR 1500 SERIES LAMPS



vsm9361
Black ABS Surface
Mount Bracket



vsm9381
Chrome ABS Surface
Mount Bracket



vsm9387
White ABS Header
Mount Bracket



vsm9393
Gray ABS Deflector
Mount Bracket with
Hot Wire



LED Clearance/Marker Lamps

Led de Despeje/Marcadoras

All Lamps 12 V Standard • Red Lens Standard

The 2105 and 1255 Series LED lamps are available with clear lenses. For Red LED order part number and add suffix "RC" (e.g.2105RC)
For Amber LED order part number and add "C" suffix (e.g.1255AC)

2105 SERIES

6 inch Sealed Rectangular LED Clearance / Marker Lamps

Features:

- Designed at 14 Volt, .060 Amp
- ABS Housing Acrylic Lens
- Sealed Water Tight Construction

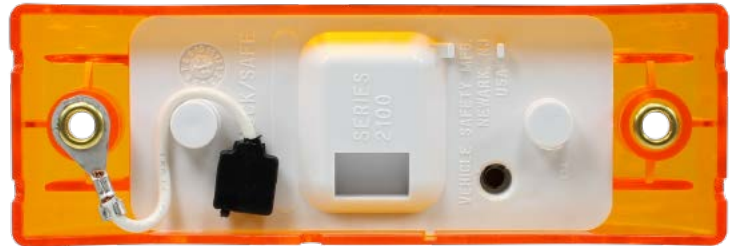
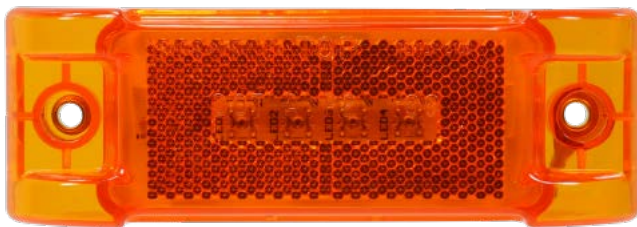

vsm9221
Hot Wire for the 2105 Series lamps

vsm2105A Amber Rectangular Clearance/Marker

2105 SERIES CLEARANCE/MARKER KITS Kit includes 9221 Hot Wire

vsm2105K 6" Red 2105 lamp with Hot Wire

vsm2105AK 6" Amber 2105A lamp with Hot Wire

Double Bulls Eye Clearance/ Marker Lamps

Industry Standard Connections

VSM1255AX Amber 16 Diode Double Bulls Eye Clearance/Marker Lamp

VSM1255X Red 16 Diode Double Bulls Eye Clearance/Marker Lamp



VSM1255AX



VSM1255X

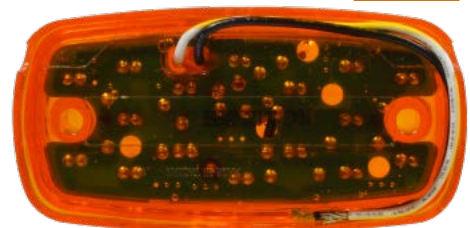

Rear View

LED Clearance/Marker Lamps

LED Micro-Marker Lamp with Grommet



3
SMT
DIODES

Features and Benefits:

- P2PC rated for combination Clearance/Marker applications.
- 180° field of illumination.
- Uses 3 SMT diodes.
- LEDs are solid state devices and no filaments and therefore are not susceptible to shock and vibration, rated life of 100,000 hours.
- Polycarbonate construction offers superior high impact resistance.
- Electronics completely sealed in epoxy to resist corrosion and moisture.
- Designed at 14 volts, 0.08 Amps.
- 100% maintenance free.



VSM3305Y183

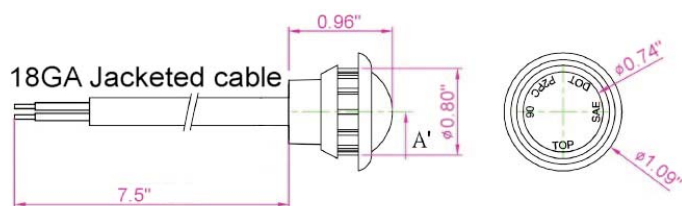

PANEL THICKNESS UP TO 0.250"

Ø 0.75" MOUNTING HOLE



VSM9835
Chrome Bezel



VSM9135
Grommet

Part Number

Description

VSM3305	Red LED Micro-Marker Light with Grommet
VSM3305Y180	Red LED Micro-Marker Light with Grommet and Molded .180 Bullet Terminal
VSM3305Y183	Red LED Micro-Marker 3 Light ID Harness Assembly
VSM3305RC	Red LED Micro-Marker with Grommet (Clear Lens)
VSM3305RCY180	Red LED Micro-Marker Light with Grommet and Molded .180 Bullet Terminal (Clear Lens)
VSM3305A	Amber LED Micro-Marker Light with Grommet
VSM3305AY180	Amber LED Micro-Marker Light with Grommet and Molded .180 Bullet Terminal
VSM3305AC	Amber LED Micro-Marker with Grommet (Clear Lens)
VSM3305ACY180	Amber LED Micro-Marker Light with Grommet and Molded .180 Bullet Terminal (Clear Lens)
VSM3305W	Clear LED Micro-Marker Light with Grommet
VSM3305WY180	Clear LED Micro-Marker Light with Grommet and Molded .180 Bullet Terminal
VSM9135	Replacement Micro-Marker Lamp Mounting Grommet
VSM9835	Chrome Bezel, For All 3305-Series Lamps

LED Clearance/Marker Lamps



Sealed Stop/Tail/Turn Lamps

Lamparas de Freno/Direccionales

All Lamps 12-Volt Standard

4000 Series

Sealed Stop/Tail/Turn Signal Lamps



VSM4064

4" Round Sealed Lamps

Features:

- Sonically sealed polycarbonate housing and lens
- Shock Safe bulb mount extends bulb life
- Accepts standard 3-prong and right angle OEM plugs

Double Contact Combination Stop, Tail, Turn Signal

VSM4064 With red lens. Replaces Truck-Lite #40202

VSM4064A With red lens.



VSM4054

4000 Series Lamps Kits with Grommet and Pigtail Double Contact Combination Stop, Tail, Turn Signal

VSM4054 VSM4064 lamp with VSM9127 grommet and VSM9124 pigtail

VSM4054A VSM4064A lamp with VSM9127 grommet and VSM9124 pigtail



VSM4057

4000 Series Lamps with Gray ABS Snap-In Flange Double Contact Lamps

VSM4067 VSM4064 lamp with gray ABS flange

VSM4067A VSM4064A lamp with gray ABS flange

4000 Series Lamps Kits with Gray Flange and Pigtail

VSM4057 VSM4064 lamp with gray ABS flange and VSM9124 pigtail

VSM4057A VSM4064A lamp with gray ABS flange and VSM9124 pigtail



VSM4058

4000 Series Lamps Kits with Gray Flange and Pigtail

VSM4058 VSM4064 lamp with black ABS flange and VSM9124 pigtail

VSM4058A VSM4064A lamp with black ABS flange and VSM9124 pigtail

Sealed Stop/Tail/Turn Lamps



Lamparas de Freno/Direccionales

All Lamps 12-Volt Standard

4000 Series Lamps with Chrome ABS Snap-In Flange Double Contact Lamps

- VSM4069** VSM4064 lamp with chrome ABS flange
- VSM4069A** VSM4064A lamp with chrome ABS flange

4000 Series Lamps Kits with Chrome Flange and Pigtail

- VSM4059** VSM4064 lamp with chrome ABS flange and VSM9124 pigtail
- VSM4059A** VSM4064A lamp with chrome ABS flange and VSM9124 pigtail



6000 Series Oval Sealed Lamps

Features:

- Sonically sealed polycarbonate housing and lens
- Double contact Shock Safe bulb mount
- Industry standard connections and pin out
- Legal in vertical or horizontal position

Combination Stop/Tail/Turn Signal Lamps

- VSM6064** Red lens. Replaces Truck-Lite #60202
- VSM6064A** Amber lens



6000 Series Lamp Kits with Grommet and Pigtail

Includes VSM6000 series oval lamp, VSM9526 rubber grommet and VSM9124 molded pigtail

- VSM6054** VSM6064 lamp with grommet and molded pigtail
- VSM6054A** VSM6064A lamp with grommet and molded pigtail



Sealed Stop/Tail/Turn Signal Lamps



Stop/Tail/Turn Lamps

Sealed Stop/Tail/Turn Signal Lamps



4500 Series

Rectangular Sealed Lamps

- Sonically Sealed Polycarbonate Housing
- Standard Plug-In Industry Connection
- High Impact Polycarbonate Construction
- Uses Standard Mounting Hole
- Heavy Duty Bulb Shock Mount

VSM4554A

Rectangular Lamp Kit. Amber Lens.

VSM4554

Rectangular Lamp Kit. Red Lens.

VSM4564A

Rectangular Amber Lamp

VSM4564

Rectangular Red Lamp

VSM9175

Rectangular Rubber Grommet



4500 Series

Backup Lamp with Reflector Lens

- Sonically Sealed Polycarbonate Housing
- Standard Plug-In Industry Connection
- High Impact Polycarbonate Construction
- Uses Standard Mounting Hole
- Heavy Duty Bulb Shock Mount

VSM4553W

Backup Lamp Kit with Reflector Lens

VSM4563W

Backup Lamp with Reflector Lens

6000 SERIES

Sealed Lamps in Stainless Steel Panels

Features:

- VSM 6000 Series sealed lamps mounted in a Hi-Polished HD corrosion-resistant stainless steel mount
- Includes rubber mounting grommet and custom Daisy-Chain Harness system

Single Sealed Oval Lamp in 8.25 inch Stainless Steel Mount

Includes 9526 Grommet and 9128 Right Angle Plug Harness

vsm6091 Red 6064 Lamp in Single-Hole Bracket

vsm6091A Amber 6064A Lamp in Single-Hole Bracket

vsm9525 Black Powder Coated Steel Oval Single-Hole Bracket

vsm9526 Oval Rubber Grommet



6091A

Two Sealed Oval Lamps in 16.5 inch Stainless Steel Mount

Includes 9526 Grommets & 91282 Right Angle 2-Plug String Harness

vsm6092 Two Red 6064 Lamps in 2-Hole Bracket

vsm6092A Two Amber 6064A Lamps in 2-Hole Bracket

vsm91282 Molded Right Angle 2-Plug String Harness

vsm9526 Oval Grommet



6092

Three Sealed Oval Lamps in 25 inch Stainless Steel Mount

Includes 9526 Grommets & 91283 Right Angle 3-Plug String Harness

vsm6093 Three Red 6064 Lamps in 3-Hole Bracket

vsm6093A Three Amber 6064A Lamps in 3-Hole Bracket

vsm91283 Molded Right Angle 3-Plug String Harness

vsm9526 Oval Grommet



6093A



Four Sealed Oval Lamps 33 inch Stainless Steel Mount

Includes 9526 Grommets & 91284 Right Angle 4-Plug String Harness

vsm6094 Four Red 6064 Lamps in 4-Hole Bracket

vsm6094A Four Amber 6064A Lamps in 4-Hole Bracket

vsm9564 Stainless Steel Oval 4-Hole Bracket Only

vsm91284 Molded Right Angle 4-Plug String Harness

vsm9526 Oval Grommet

6094A

Replaceable Bulb Type

Sealed Stop/Tail/Turn Signal Lamps



Round 2-Stud Mount Lamps

VSM522 Stop/Tail/Turn Lamp

Features:

- Rustproof
- Rugged non-corrosive permamold housing
- Snap-on lens
- With license plate illuminator
- Replaces Signal-Stat #540



Flush-Mount Steel Black Enamel Lamps

Tightly sealed against dirt and dust

Features:

- Size: 5 1/4" Diameter x 1 1/8" Depth under flange
- Mounts through 4 1/2" diameter cutout

Replacement Parts

- Lens Kit: VSM9021
- Lens VSM9016
- Two-Wire Pigtail: VSM9101
- One-Wire Pigtail: VSM9102
- Double Contact Bulb: 1157
- Single Contact Bulb: 1156

Single Contact Flush-Mount Turn Signal Lamp

VSM2601 Red lens flush-mount turn signal lamp

VSM2601A Amber lens flush-mount turn signal lamp

REPLACEABLE BULB TYPE

FLUSH MOUNT RUBBER HOUSING

- Rubber housing stays flexible, even at low temperatures
- Snap-in lens
- Completely non-ferrous
- All brass socket and bracket assembly

Size: 5½" diameter. Mounting: Three 7/32" diameter mounting holes
Mounts in a 4½" x 1½" deep hole.

Replacement Parts: Red lens: vsm 9029; Amber lens vsm 9029A
• Pigtail vsm 9101 • Double contact bulb 1157



4522

Double Contact Stop, Tail, Turn Signal Lamp

vsm4522 With red lens for use as combination rear lamp

THINLINE LED S/T/T LIGHT BAR

vsm7464 for use as combination rear lamp

- Low profile hard wire design
- Sealed polycarbonate waterproof construction
- Surface mount on 16 1/8" centers
- 17"L x 1 3/8" W x 1" H
- 8-14 VDC, .350/.22 Amp
- 11 Superflux LED



7464

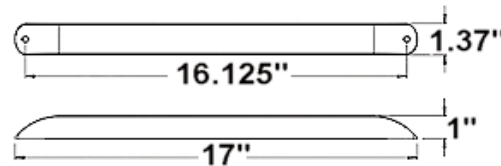

11
DIODES

UNIVERSAL SURFACE MOUNT

Ideal for light duty trailers, golf carts and industrial vehicles.

- Raised polycarbonate lens with pillow optics
- Stamped galvanized back plate

Replacement Parts: Red lens vsm 9372;
Single contact bulb 1156; Double contact bulb 1157

Double Contact Stop, Tail, Turn Signal Lamp

vsm548 With red lens for use as combination rear lamp

vsm548A With amber lens for use as park and turn signal lamp



548A

548

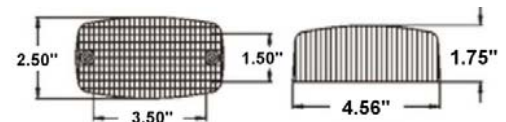

LED UNIVERSAL SURFACE MOUNT

vsm550 Rectangular Surface Mount S/T/T lamp with 18 diodes

- Ideal for light duty trailers, golf carts and industrial vehicles
- Raised polycarbonate lens
- Double contact
- Available in red LED only



550

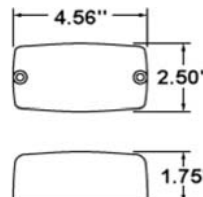

18
DIODES



OEM Rear Combination Lamps

Combinacion de Lamparas Traseras Para Equipo Original

All Lamps 12 V Standard • Red Lens Standard

VSM/OEM REPLACEMENT CHART

3-Stud Universal Rear Combination Lamp



VSM4027

Universal - Fits Virtually All Applications
Dual Optic Lens. Rear Pigtail Connection

Stud Mounting Pattern

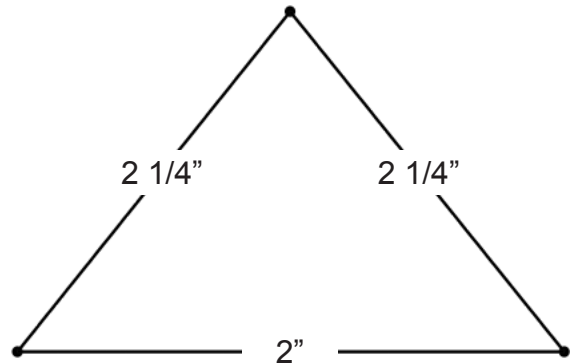

FREIGHTLINER

VSM # *FREIGHTLINER #*

5014 681-544-04-1

MACK

VSM # *MACK #*

5016 14M052AM

4028 14M052M

4028 4028

NAVISTAR

VSM # *NAVISTAR #*

5014Y102 1661282C9

2009909C9

5023Y102 1661281C91

2009908C9

2-Stud OEM Mack Replacement (with harness)



VSM4028

Shock Safe. Includes 30" OEM Pigtail.
Right and Left Side. Direct Replacement For:

Mack 14MO444RP1; 14MO444RP4

VSM4029

Standard Mount Pigtail. OE Replacement

Stud Mounting Pattern



PETERBILT

VSM # *PETERBILT #*

5013 16-06160L

5014 16-06160R

16-06292

5023 16-06291

VOLVO/GM

VSM # *VOLVO/GM #*

5013 5565731

15574697

15613943

15684994

5014 15565732

15574696

15684995

5014Y101 8067856

5023 8067855

UNIVERSAL

VSM # *APPLICATION*

4027 3 Stud 12"

4028 2 Stud 39"

4029 2 Stud 12"

Replacement Lens: VSM9049 for all Rear Combination Lamps

OEM Rear Combination Lamps

REPLACEABLE BULB TYPE

METRI-PACK

COMBINATION STOP/TAIL/SIGNAL LAMPS

3-Stud with Metri-Pack Connector on Right Side

vsm5013 Left Side Replacement for: **PETERBILT** 16-06160L
GM 15565731; 15574697; 15613943; 15684994
FREIGHTLINER 681-544-04-03



3-Stud with Metri-Pack Connector on Left Side

vsm 5014 Right Side Replacement for:
PETERBILT 16-06160R; 16-06292
GM 15565732; 15574696; 15613944; 15684994

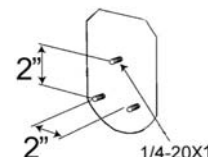

3-Stud with Metri-Pack Connector on Left Side

vsm 5014Y101 Right Side Replacement for: **VOLVO/GM** 8067856
vsm 5014Y102 Right Side Replacement for: **NAVISTAR** 1661282C91; 2009909C91

2-Stud with Metri-Pack Connector on Left Side

vsm 5016
Replacement for **MACK** 14M052AM; 14M052M



2-Stud with Metri-Pack Connector on Right Side

vsm 5015

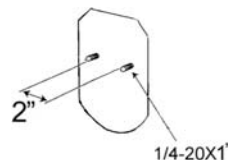

5016

3-Stud w/Double Left & Right Side Metri-Packs

vsm5023 Left Side Replacement for: **PETERBILT** 16-06291,
VOLVO/GM 8067855

vsm 5023Y102 Left Side Replacement for
NAVISTAR 1661281C91; 2009908C91

vsm5024 Right Side Replacement for:
FREIGHTLINER 681-544-05-03



5023

METRI-PACK HARNESES

- vsm9464** 4-Wire Harness • 22" in length, 16 gauge wire.
- vsm9466** Cross-Over Harness • 78" in length, 16 gauge wire.
- vsm9469** Daisy Chain Harness • 36" in length, 16 gauge wire.
- vsm9470** 5-Wire Harness • 22" in length, 16 gauge wire.

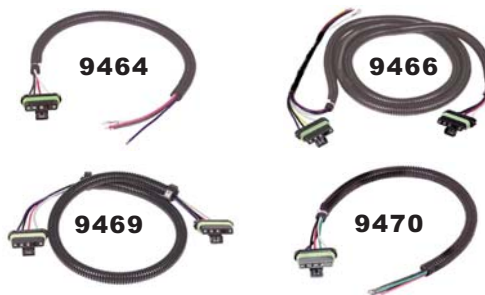



OEM Rear Combination Lamps

Combinacion de Lamparas Traseras Para Equipo Original

All Lamps 12-Volt Standard.

Multi-Function LED Box Lamps Combination Stop/Tail/Signal Lamps

Full function integrated LED combination lamp. Functions include stop/tail. turn/back-up. Reflex reflector and license plate illuminator.

- All function utilize Super Flux LED technology
- Attractive multiple diode design
- Gasket between lens and housing protects against moisture intrusion
- Epoxy encapsulated electronics for protection against moisture, vibration, and corrosion
- Contains 16 S/T/T diodes, 18 back-up diodes, and 4 license plate illuminator diodes
- Mounting hardware included
- Polycarbonate housing with acrylic lens
- Voltage: 12 - 13.5 Volts

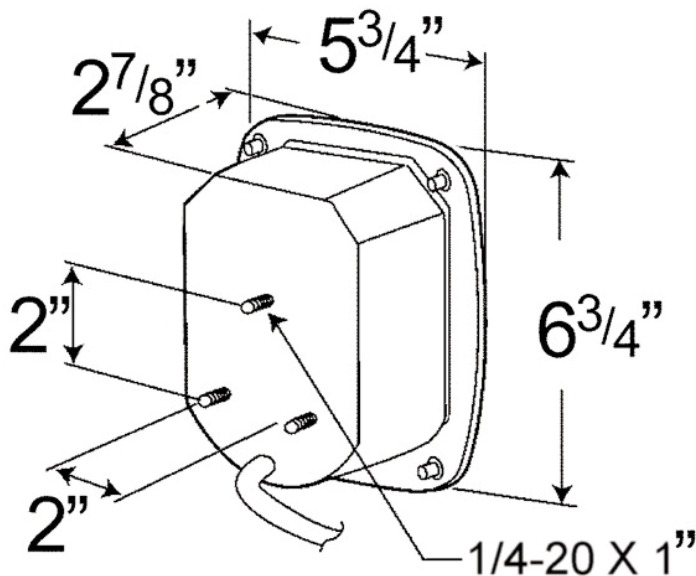

OEM Rear Combination Lamps

OEM Rear Combination Lamps



Combinacion de Lamparas Traseras Para Equipo Original

All Lamps 12 V Standard

OEM LED UPGRADE

COMBINATION STOP/TAILO/TURN/BACK-UP/ REFLECTOR/LICENSE ILLUMINATOR

3-Stud with Metri-Pack Connector on Right Side



5014LED

VSM5013LED LH LED Upgrade for: PETERBILT 16-06160L
 FREIGHTLINER 681-544-04-03
 GM 15565731; 15574697; 15613943; 15684994
 OSKOSH2078210

3 Stud with Metri-Pack Connector on Left Side

VSM5014LED RH LED Upgrade for:
 PETERBILT 16-06160R; 16-06292
 GM 15565732; 15574696; 15613944; 15684995
 OSHKOSH 2078200

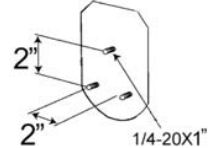

5016LED

2-Stud with Metri-Pack Connector on Left Side

VSM5016LED (RH)
 LED Upgrade for Mack 14M052AM; 14M052M

VSM5015LED (LH)

16
 DIODES
 S/T/T

18
 DIODES
 BACK UP

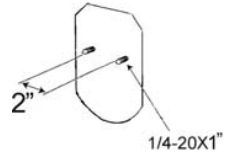

5023LED

3-Stud w/Double Left & Right Side Metri-Packs

VSM 5023LED LH LED Upgrade for: PETERBILT 16-06291
 VOLVO/GM 80678553

3-Stud w/Double Left & Right Side Metri-Packs

VSM5024LED(RH)LED Upgrade for:
 FREIGHTLINER 681-544-05-03

16
 DIODES
 S/T/T

18
 DIODES
 BACK UP

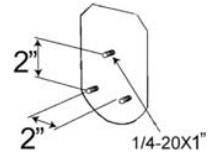

4027LED

3 Stud Universal LED Rear Combination Lamp

VSM4027LED
 3 wire 12" rear pigtail harness connection.
 Grounding function through mounting studs.

16
 DIODES
 S/T/T

18
 DIODES
 BACK UP

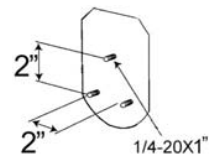

4028LED

2 Stud Mack LED Rear Combination Lamp

VSM4028LED
 OEM 39" pigtail harness w/ring terminals.
 LED Upgrade for MACK 14M0444RP1;
 14M0444RP4.
 Grounding function through mounting studs.

16
 DIODES
 S/T/T

18
 DIODES
 BACK UP

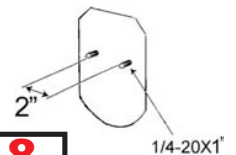



LED Stop/Tail/Turn Lamps

LED Stop/Tail/Turn Signal Lamps

21 Diodes Sealed LED Stop/Tail/Turn Lamps

- Polycarbonate lens
- Zinc die cast housing
- SMD Diodes



2705

SINGLE FACE BLACK HOUSING

- 21 SMD Diode pattern design
- Unique optics design displays a full pattern of light
- Very low power consumption
- Epoxy encapsulated electronics
- Sonically sealed waterproof construction
- Extremely long service life
- Zinc die cast housing with black finish
- Mounting hardware included
- Designed at 12.8V Major .250 / .019 Amp (RED LED)

2705W - Single face White LED



3812LED

DOUBLE FACE CHROME HOUSING

- 21 SMD Diode pattern for the Amber and the Red lens
- Unique optics design displays a full pattern of light
- Very low power consumption
- Epoxy encapsulated electronics
- sealed waterproof construction
- Extremely long service life
- Zinc die cast housing with chrome plating finish
- 1 Stud mount suitable for horizontal or vertical orientation
- Mounting Hardware included
- Designed at 12.8V Major .625 / .045 Amp

3812LED - Double face Red/Amber LED



DIE CAST REPLACEABLE BULB TYPE

SINGLE FACE • STUD MOUNT

Double contact wiring for use as combination stop, tail and turn signal lamps.

Size: 4 1/8" diameter x 2" D 1/2"-20 Stud 7/8" Long



2702

BLACK FINISH

Double Contact Stop, Tail, Signal Lamps

vsm2702 Red lens. Stop, tail, turn signal lamp

vsm2702A Amber lens. Turn signal lamp

VSM/OEM REPLACEMENT CHART

PETERBILT

VSM #	PETERBILT #
4800	4800
4801	4801

FREIGHTLINER

VSM #	FREIGHTLINER #
4805AAY115	681-8220-020
4805AAY118	681-8220-120
4805AY116	A06-18900-000
4805AY117	A06-18900-001

VOLVO

VSM #	VOLVO #
4800	4800
4801	4801
4805	4805

GM

VSM #	GM #
4874AA	796315

WESTERN STAR

VSM #	WESTERN STAR #
4800	4800
4801	4801

MACK

VSM #	MACK #
4805AAY2	47M0453AM2
4805AAY4	47M0453AM4
3801Y67	47M0251P1
3802Y67	47M0251P2

NAVISTAR

VSM #	NAVISTAR #
	444660C91



vsm4800 Black **vsm4801 Chrome**
 Replacement Front Turn Signal Lamps for:
GM, PETERBILT, VOLVO, WESTERN STAR
 • Lens: Signal **vsm9063**, Lens **vsm9063A**
 • Bulb: Signal **1156**, Marker **1895**



vsm3801Y67 Black **vsm3802Y67 Chrome**
 Replacement Front Signal Replacement Front Sign
 for **MACK 47M0251P1** for **MACK 47M0251P2**
 • Lens Kit **vsm9021** • Lens **vsm9016**
 • Single contact bulb **1156**

MACK



vsm4805AAY2 Black **vsm4805AAY4 Chrome**
 Replacement Front Signal Replacement Front Sig
 for **MACK 47M0453AM2** for **MACK 47M0453AM4**
 • Lens: Signal **vsm9079A**
 • Bulb: Signal **1156**, Marker **1895**



FREIGHTLINER

vsm4805AAY115

Front Turn Signal Lamp with 7" OEM Harness
Replacement for **FREIGHTLINER** 681-8220-020

- Lens: Signal **vsm9079A**, Marker **vsm9080A**
- Bulb: Signal **vsm1156**, Marker **vsm1895**



FREIGHTLINER

vsm4805AAY118

Front Turn Signal Lamp with 75" OEM Harness
Replacement for **FREIGHTLINER** 681-8220-120

- Lens: Signal **vsm9079A**, Marker **vsm9080A**
- Bulb: Signal **vsm1156**, Marker **vsm1895**



FREIGHTLINER

vsm4805AY116 (Left Side)

Front Turn Signal Lamp with 49" OEM Harness
Replacement for **FREIGHTLINER** A06-18900-000

- Two 5/16" studs on 2" centers
- Lens: Signal **vsm9063** and **vsm9063A**
- Bulb: Signal **vsm1156**, Marker **vsm1895**



FREIGHTLINER

vsm4805AY117 (Right Side)

Front Turn Signal Lamp with 49" OEM Harness.
Replacement for **FREIGHTLINER** A06-18900-001

- Two 5/16" studs on 2" centers
- Lens: Signal **vsm9063** and **vsm9063A**
- Bulb: Signal **vsm1156**, Marker **vsm1895**

Front Turn Signals



Volvo VSM4805

Replacement Front Turn Signal Lamp for VOLVO



Lens **VSM9063A** - Bulb **VSM1156** - Marker **VSM1895**



LED Front Turn Signals

Lamparas de Freno/Traseras/Direccionales

All Lamps 12 V Standard

LED DOUBLE FACE TURN SIGNAL LAMP

FEATURES AND BENEFITS:

- All functions utilize Super Flux LED technology
- Amber and Red face each containing 21 Super LED
- Attractive multiple diode design
- Left and Right options with side marker
- Side marker contains 3 Super LED
- Mounting Hardware included
- Voltage/Amp 12.8V -0.61/011 amp

4801LEDR AND 4801LEDL

- Chrome plated
- 1 stud housing with polycarbonate lenses
- Built in side marker with reflector
- Epoxy encapsulated electronics and waterproof construction

21 RED DIODES	21 AMBER DIODES	3 DIODES SIDE MRKR
----------------------------	------------------------------	---------------------------------



4801LEDR 4801LEDL

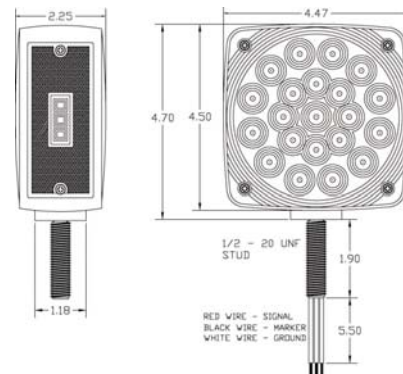

4805LEDR AND 4805LEDL

- Chrome plated
- 2 stud housing with polycarbonate lenses
- Built in side marker with reflector
- Epoxy encapsulated electronics and waterproof construction

21 RED DIODES	21 AMBER DIODES	3 DIODES SIDE MRKR
----------------------------	------------------------------	---------------------------------



4805LEDR 4805LEDL

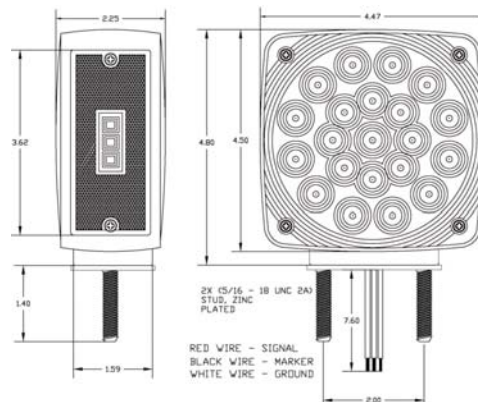

OEM Front Turn Signals



2264A

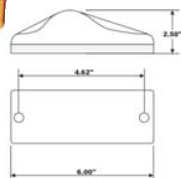

vsm 2264A Mid-Turn Signal Lamp

- Auxiliary side-turn marker/clearance lamp
- Lens and housing sealed against vibration
- Heavy-Duty Shock-Safe mounted bulb
- Uses Industry Standard Connection
- Accommodates vsm9128 pigtail



6164A

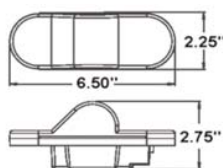

vsm 6164A Mid-Turn Signal

- Sealed polycarbonate lens and housing
- "Shock-Safe" bulb mount
- Standard plug-in connection

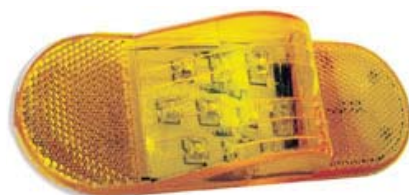

6564A

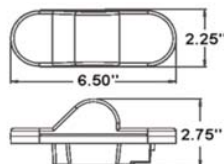

vsm 6564A LED Sealed Mid-Turn Signal Lamp

- Amber sealed 9 Diode LED auxiliary turn/marker lamp
- Polycarbonate lens and housing. Designed at 14V
- .210/.090 amps.
- Uses industry standard plug-in connection



1348A

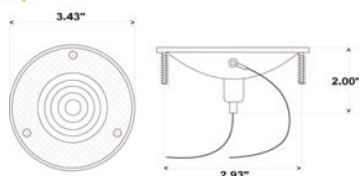

vsm 1348A Mack OEM Replacement Marker Lamp

- Amber replacement side fender marker for Mack
- Gasket included
- Ground wire for mounting on non-metallic surfaces

vsm 1348AY93 Mack OEM Replacement with 93" OEM Harness

- Direct OEM side fender marker replacement lamp
- With 93" OEM harness
- Replacement for MACK 38MO343RP3

vsm 1349A Mack Side Fender Lamp

- Steel plated housing
- Gasket included - No ground wire
- Replacement Parts: • vsm9092A • Bulb 67



Lamparas LED Marcadoras de Cabina

All Lamps 12-Volt Standard.

Large OEM -Style Aerodynamic Cab Marker

VSM1385A

Used on Ford, NAVISTAR, and Freightliner

Size: 3 3/16" W x 11" L x 3 1/8" H



LED Cab Marker Lamps

Die Cast Chrome with Shock Safe Bulb Mount

VSM1301 Red Chrome Shock Safe Cab Marker

VSM1301A Amber Chrome Shock Safe Cab Marker

- Strong Die Cast Housing with Adjustable Base and Snap out Lens
- O-ring Secures Lense and Seals Out Dirt and Moisture
- Thick Molded Rubber Mounting Pad

Replacement Parts

Red Lens: VSM9008

Amber Lens: VSM9008A

Bulb: 67



Sonically Sealed Cab Marker Lamp

VSM1310A

Replacement Cab Market for Ford and Universal Applications

Size: 5 15/16" L x 3 5/8" W x 1 5/8" H

Mounting: Use Two #10 Screws on 2 3/4" Centers



Cab Market with Rubber Base Housing VSM1313A



- Polycarbonate Lens

- Amber Lenses Only

Replacement Cab Market for Chevrolet/GMC

Size: 3 1/4" Diameter x 2" D

Mounting: Use Two #10 Screws on 2 3/4" Centers

Lamparas LED Marcadoras de Cabina

All Lamps 12-Volt Standard.

Plastic Housing - Flush-Mount Cab Marker Lamp

VSM1320A Ford OEM Replacement Cab Market Lamp

- Single screw amber lens
- Rust and corrosion proof
- Includes mounting gasket

Size: 5 9/16" L x 2 3/8" W x 1 3/4" H

Mounting: Two holes for #10 screws on 3" centers

Replacement Parts: Lens VSM9067A



Large OEM-Style Cab Marker Lamp VSM1346A

Used on Peterbilt, Kenworth, Ford, Navistar, and Western Star Trucks

- High impact plastic, chrome plated
- Thick neoprene mounting pad
- Superior protection against rust and corrosion
- Amber lens

Size: 10 7/8" L x 4 9/16" W x 2 3/4" H

Mounting: Two holes for #10 screws on 9 1/8" centers

Replacement Parts: Bulb 194



Led de Despeje/Marcadoras

ML2K SERIES

Oblong LED & Incandescent Marker Lamps

Size: 6.6" L x 2.2" W x .92" H

Mounts with 2 # 8 screws on 4.625" centers

Features:

- Popular Oblong Design
- Completely Sealed and Water Tight
- Corrosion Resistant Chrome-Plated Bezel
- No Exposed Fasteners. Surface Mount
- vsm9122 Industry Standard Plug-in Connection
- D.O.T. Compliant
- Made in U.S.A.

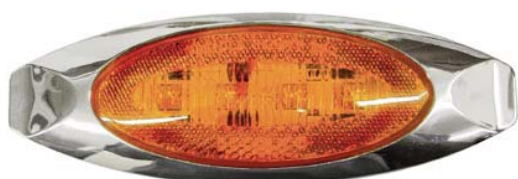

2005A



INCANDESCENT BULB VERSION

14v /.33 amp / 2 cp

vsm2000 ML2K Red Lamp w/Chrome Bezel

vsm2000A ML2K Amber Lamp w/Chrome Bezel

Incandescent Lamps with Reflex Lens & Chrome Bezel

vsm2011 ML2K with Red Reflex Lens & Chrome Bezel

vsm2011A ML2K with Amber Reflex Lens & Chrome Bezel

ML2K LED VERSION

4 Diodes /14v /.065 amp

vsm2005 ML2K Red LED Lamp w/Chrome Bezel

vsm2005A ML2K Amber LED Lamp w/Chrome Bezel

vsm2005RC Red LED Lamp w/Clear Lens & Chrome Bezel

vsm2005AC Amber LED Lamp w/Clear Lens & Chrome Bezel

ML2K LED Lamps with Reflex Lens & Chrome Bezel

vsm2015 ML2K LED w/Red Reflex Lens & Chrome Bezel

vsm2015A ML2K LED w/Amber Reflex Lens & Chrome Bezel

vsm2015RC Red LED w/Clear Reflex Lens & Chrome Bezel

vsm2015AC Amber LED w/Clear Reflex Lens & Chrome Bezel

Lamps are also available with 2 way metripack connector
or .180 molded bullet terminals



Add suffix (Y100) to std part No.
for lamps with metripack connector



Add suffix (Y180) to std part No.
for lamps with .180 molded terminals

ML3K SERIES

Oval LED & Incandescent Marker Lamps

Size: 3" L X 2" W X .94" H

Mounts with 2 # 8 screws on 1.282" centers

Features:

- Corrosion Resistant Chrome-Plated Bezel
- D.O.T. Compliant
- Made in U.S.A.



3000A



INCANDESCENT BULB VERSION

14v /.33 amp / 2 cp

vsm3000 ML3K Red Lamp w/Chrome Bezel

vsm3000A ML3K Amber Lamp w/Chrome Bezel

ML3K LED VERSION

2-Diodes /14v /.065 amp

vsm3005 ML3K LED Lamp w/Red Lens and with Chrome Bezel

vsm3005A ML3K LED Lamp w/Amber Lens with Chrome Bezel

vsm3005RC LED Lamp, Red Diodes, Clear Lens with Chrome Bezel

vsm3005AC LED Lamp, Amber Diodes, Clear Lens with Chrome Bezel

ML4K SERIES

ML4K LED VERSION

- Operates from 8 - 16 Volts
- 2 SMD LEDs /14v /.05 amp
- Mounts on 1.937" centers
- 1415 and 1415A Kits include chrome bezel



1405 & 1405A

vsm1405 LED Marker Lamp, Red Diodes

vsm1405A LED Marker Lamp, Amber Diodes

vsm1415 LED Marker Lamp, Red Diodes and Chrome Bezel

vsm1415A LED Marker Lamp, Amber Diodes and Chrome Bezel



1415A



INCANDESCENT BULB TYPE

2300 SERIES GUARDIAN SEALED LAMPS

Combination 2-Bulb Sealed Clearance/Side Marker Lamps

Features:

- 12 volt, Two 12,000 Hour Rated Bulbs
- Vibration-Resistant Heavy Duty Shock Mounting System
- Sealed Lens and High Impact Base Housing
- .156 Brass Male Bullet Terminals
- Uses Industry Standard 2-Pin Plug-in Connection

vsm2300 Red 2-Bulb Sealed M/C Lamp

vsm2300A Amber 2-Bulb sealed M/C Lamp

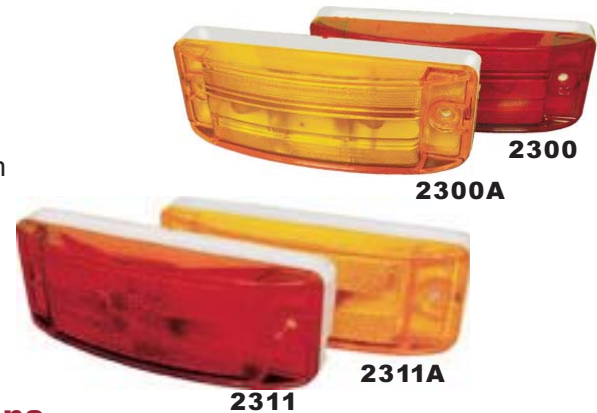

2300 Series Sealed Lamps With Reflex Lens

vsm2311 Red 2-Bulb Sealed Clearance/Marker with Reflex Lens

vsm2311A Amber 2-Bulb Sealed Clearance/Marker with Reflex Lens



Industry standard 2-male pin plug-in connection

2400 SERIES CENTURIAN SEALED LAMPS

Combination Clearance/Marker & Auxiliary Stop/Side Turn Signal Position Indicator

Features:

- 12.8 volt, Single #571 HD Bulb 32/3 cp
- Vibration-resistant Heavy Duty Shock Mounting System
- Sealed Lens and High Impact Base Housing
- .156 Brass Male Bullet Terminals
- Uses 9134 pigtail

vsm2464 Red sealed multi-function lamp

vsm2464A Amber sealed multi-function lamp



Industry standard 3-male pin plug-in connection



9134

Sealed Clearance/Markers



Lampara Selladas de Despeje/Marcadoras

All Lamps 12-Volt Standard - Red Lens Standard

Incandescent Bulb Type

1010 Series

2 1/2" Clearance/Marker Lamps

Features

- Sonically sealed
- Polycarbonate housing and lens
- 14-Volt, .33 Amp 15,000 hour bulb rated at 2.0 cp



1010 Series Lamp Kits

VSM1010K 1010 lamp with 9119 grommet & 9122 pigtail

VSM1010AK 1010A lamp with 9119 grommet & 9122 pigtail

Sealed Clearance/Marker Lamps

VSM1010 Red 2 1/2" Sealed Lamp

VSM1010A Amber 2 1/2" Sealed Lamp

Lamps with Flush-Mount Flange

1010 series sealed lamps with gray polycarbonate flush-mount flange

VSM1010AF 1010A lamp with gray flush-mount flange



1011 Series

2 1/2" Clearance/Marker Lamps with Reflector Lens

- Sonically sealed polycarbonate housing and reflector lens
- 14 Volt, .33 Amp bulb rated at 2.0 cp
- 15,000 hour rated bulb
- Size: 2 1/2" diameter x 3/4" depth
- Mounting: Use VSM9122 plug-in connection. Mount between 15" and 60" from ground level when used as a reflector and lamp on trailers less than 80" wide.

VSM1011 Red 2 1/2" sealed lamp with Reflector Lens

VSM1011A Amber 2 1/2" sealed lamp with Reflector Lens





Sealed Clearance/Markers

Sealed Clearance/Marker Lamps

Lampara Selladas de Despeje/Marcadoras

All Lamps 12-Volt Standard - Red Lens Standard

Incandescent Bulb Type

1030 Series

2" Clearance/Marker Lamps

Features

- Sonically sealed • Polycarbonate housing and lens • 14-Volt, .33 Amp 15,000 hour bulb rated at 2.0 cp
- Size: 2" diameter x 3/4" depth • Mounting: Use quick connect plug-in VSM9122

1030 Series Clearance/Marker Lamps

VSM1030 Red 2" sealed lamp

VSM1030A Amber 2" sealed lamp

VSM1030



VSM1030A



VSM1030AF

Lamps with Flush-Mount Flange

VSM1030F 1030 lamp with gray polycarbonate flush mount flange

VSM1030AF 1030A lamp with gray polycarbonate flush mount flange

1030 Series Surface Mount Lamps

1030 lamp with gray polycarbonate surface mount flange

VSM1030SF

1030 Red sealed lamp with gray polycarbonate surface mount flange

VSM1030ASF

1030 Amber sealed lamp with gray polycarbonate surface mount flange

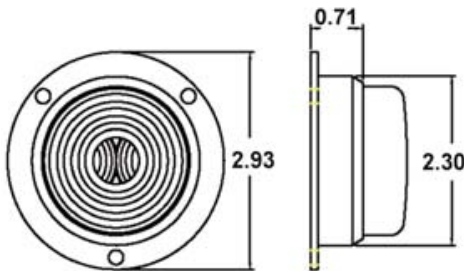

VSM1030ASF & 1030SF

Lamparas Selladas de Despeje/Marcadoras

All Lamps 12 V Standard • Red Lens Standard

INCANDESCENT BULB TYPE

1500 SERIES

2.5 inch Sealed Rectangular One Bulb Clearance/Marker Lamps

- Features**
- Hi-impact polycarbonate resists breakage and corrosion
 - Sonically welded one-piece design protects against moisture and corrosion
 - Sealed one bulb lamp, 15,000 hour rated bulb life
 - Plug-in contacts specially treated to ensure positive electrical connection
 - Size: 2.5" L x 1.25" W x 0.875" D
 - Replaces Truck Lite #15200



1500

1500A

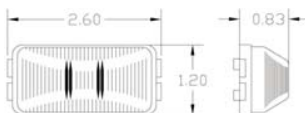

1500 SERIES SEALED RECTANGULAR LAMPS

- vsm1500** Red Rectangular Sealed One Bulb Lamp
- vsm1500A** Amber Rectangular Sealed One Bulb Lamp
- vsm1500W** Clear Rectangular Sealed One Bulb Lamp

Standard Connection



The 1500 Series lamps have industry standard connections

1500 SERIES LAMP KITS WITH BRACKET & PIGTAIL

1505 Series Lamp Kits with Bracket and Pigtail

- vsm1560K** Red Lamp with 9361 ABS Black Bracket and 9122 Pigtail
- vsm1560AK** Amber Lamp with 9361 ABS Black Bracket and 9122 Pigtail

- vsm1580K** Red Lamp with 9381 ABS Chrome Bracket and 9122 Pigtail
- vsm1580AK** Amber Lamp with 9381 ABS Chrome Bracket and 9122 Pigtail

- vsm1586K** Red Lamp with 9387 ABS Header Mount and 9122 Pigtail
- vsm1586AK** Amber Lamp with 9387 ABS Header Mount and 9122 Pigtail

- vsm1592K** Red Lamp with 9393 ABS Branch Deflector Bracket and Hot Wire
- vsm1592AK** Amber Lamp with 9393 ABS Branch Deflector Bracket and Hot Wire



1580K

1586AK

1592K

SURFACE MOUNT BRACKETS FOR 1500 & 1505 SERIES LAMPS



vsm9361 Black ABS Surface Mount Bracket



vsm9381 Chrome ABS Surface Mount Bracket



vsm9387 White ABS Header Mount Bracket



vsm9393 Gray ABS Deflector Mount Bracket with 9526 Hot Wire

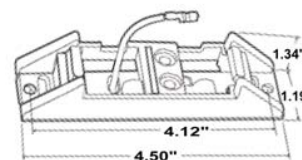
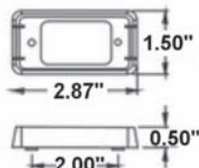
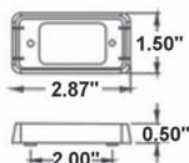

INCANDESCENT BULB TYPE

1900 SERIES

3.87 inch Sealed Rectangular Two Bulb Clearance/Marker Lamps

Features

- Replaces Truck Lite #19200
- Sonically sealed polycarbonate lens and housing
- PC rating allows lamp to function as both a marker and clearance lamp when properly mounted
- 15,000 hour rated bulb life



Standard Connection

The 1900 Series lamps have industry standard connections

1900 SERIES SEALED RECTANGULAR LAMPS

Size: 3.87" L x 1.2" W x .830" D

vsm1900 Red rectangular sealed clearance/marker lamp

vsm1900A Amber rectangular sealed clearance/marker lamp

vsm1900W Clear rectangular sealed utility lamp

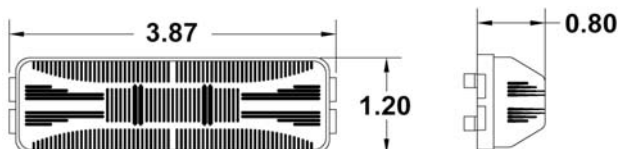

1900 SERIES LAMP KITS

Kits consist of 1900 series lamp, surface mounting bracket and a hot wire

vsm1988K Red rectangular lamp with 9389 surface mount bracket and hot wire kit

vsm1988AK Amber rectangular lamp with surface mount bracket and hot wire kit



1900 SERIES BASE MOUNT KIT & ASSEMBLY

vsm9389 Gray ABS surface mount bracket with hot wire kit

vsm9256 Hot Wire for 1900 Series lamps

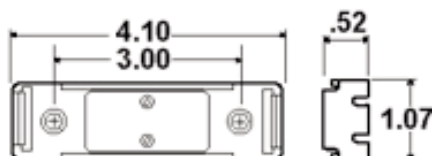

Lens Colors: Red Standard -.ADD suffix (A) for Amber; (W) for Clear accessory use only

SEALED INCANDESCENT BULB TYPE

2100 SERIES

6 inch Sealed Rectangular Clearance / Marker Lamps

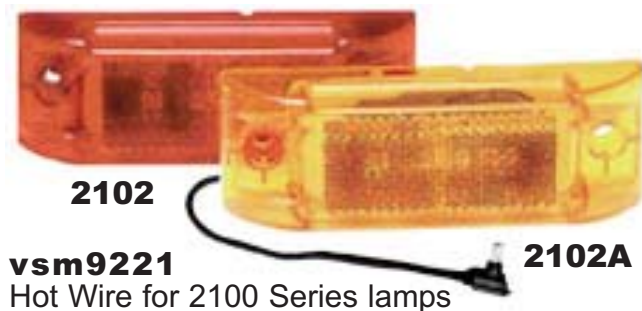

2102

vsm9221

Hot Wire for 2100 Series lamps

2102A

2100 SERIES CLEARANCE/MARKER KITS

Kit includes 9221 Hot Wire

vsm2102 Red 2101 lamp with Hot Wire

vsm2102A Amber 2101A lamp with Hot Wire

Features:

- ABS housing with acrylic lens
- Shock mounted, internal electrical connections sealed in epoxy for maximum weather resistance
- 12V designed at 14V, .33 Amp, 2cp

REPLACEABLE BULB TYPE

1200 SERIES Double Bulls-Eye Clearance/Markers

Available With Die Cast Base or Permamold Housing

Die Cast Base, Shock Safe 1200 Series Lamps



1211A

Permamold Housing 1200 Series Lamps

- Hi-Impact, corrosion-proof ABS plastic housing
- Two heavy duty 194 bulbs

vsm1211 Red Double Bulls-Eye Clearance/Marker

vsm1211A Amber Double Bulls-Eye Clearance/Marker

Size: 4" L x 2 "W x 1½ "D
Mounting: Two #10 screws on 3" centers
Replacement Parts:
• Lens only: Red vsm9007; Amber vsm9007A • Bulb194



vsm9179 Die Cast Chrome Safeguard

Provides extra lens and lamp protection for vsm1200 Series lamps
Size: 5 7/16" L x 2 3/8" W x 1 1/8" D • Mounting: Two #10 screws on 4 3/4" centers

Lens Colors: Red Standard -.ADD suffix (A) for Amber; (W) for Clear accessory use only

Lamparas Despeje/Marcadoras

All Lamps 12 V Standard • Red Lens Standard

REPLACEABLE BULB TYPE

OBLONG TWO-BULB WITH REFLEX LENS

vsm1261

vsm1261A

- High-Impact ABS base
- Shock safe bulb sockets
- Strong acrylic lens, fade-resistant
- Snap-on lens

Size: 4 1/8" L x 2" W x 1 1/32" H

Mounting: Two holes on 3" centers #10 screws

Replacement Parts: Red Lens vsm9011 Amber Lens vsm9011A • Bulb 194

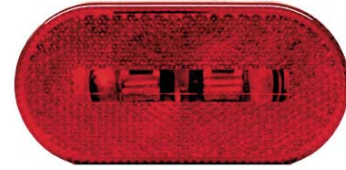

1261

1259 SERIES Cats-Eye Optic Clearance /Markers

vsm1259 Red Cats-Eye Optic Clearance/Marker Lamp

vsm1259A Amber Cats-Eye Optic Clearance/Marker Lamp

- Hi-Impact ABS housing
- Two heavy duty 194 bulbs
- Snap-on lens

Size: 4" L x 2" W x 1"D

Mounting: Two #10 screws on 3" centers

Replacement Parts: Red Lens vsm9093 • Amber Lens vsm9093A • Bulb 194



1259

1259A

THIN-LINE CLEARANCE/MARKER

vsm1549

vsm1549A

- High impact materials
- Snap-on lens
- Heavy duty wedge base bulb
- Side or rear wire exit

Size: 5" L x 2 5/32" W x 1 15/32" H

Mounting: Two 1/4" holes on 4" centers

Replacement Parts: Red Lens vsm9009 • Amber Lens vsm9009A • Bulb 194



1549

SURFACE MOUNT CLEARANCE/MARKER

vsm1550 & vsm1550A

- Corrosion-proof outside mounting
- Snap-on lens
- Heavy duty wedge base bulb
- Fruehauf side marker

Size: 4 1/8" L x 1 11/32" W x 1 15/32" H

Mounting: Two 13/64" holes on 3 5/8" centers

Replacement Parts: Lens Kit for Fruehauf vsm9061 • Red Lens vsm9059 • Amber Lens vsm9059A • Bulb 194



1550A



1559

ALUMINUM ARMORED LAMPS

vsm1559 Red Armored Lamp

vsm1559A Amber Armored Lamp

- Stainless clip socket
- Aluminum die cast housing
- Universal mounting

Size: 5 $\frac{7}{8}$ " L x 2 $\frac{1}{8}$ " W x 1 $\frac{1}{2}$ " H

Mounting: Two $\frac{1}{4}$ " holes on 4 $\frac{3}{8}$ " centers on four $\frac{13}{64}$ " holes on 3 $\frac{7}{8}$ " x 1 $\frac{3}{16}$ " centers

Replacement Parts: Lens: Red vsm9014; Amber vsm9014A • Bulb 67



1520A

SURFACE MOUNT CLEARANCE MARKER

vsm1520 Red Armored Lamp

vsm1520A Amber Armored Lamp

- Molded housing and snap-on lens
- Shock safe for extended bulb life
- Corrosion-proof • Easy bulb and lens replacement • 2 cp bulb (RV)

Size: 3 $\frac{1}{2}$ " L x $\frac{3}{4}$ " W x 1" H • Mounting: Two screws on 3" centers

Replacement Parts: Lens: Red vsm9082; Amber vsm9082A • Bulb 194

Lens Colors: Red Standard - ADD suffix (A) for Amber; (W) for Clear use only



LED Identification Bars

Barras de Identificacion Con Led

All Lamps 12 V Standard • Red Lens Standard



10153



1015A3S

1015 SERIES 2.5" LED IDENTIFICATION CLUSTER BARS

- Industry standard mounting holes.
- Three sealed 2.5" LED lamps mounted on 6" centers. Bar 16" L x 2" W.
- Includes vsm9309 3-plug harness

With Black Powder Coated Steel Bar

- vsm10153** Three 1015 Red Lamps / Black Powder Coated Steel Bar
- vsm1015A3** Three 1015A Amber Lamps / Black Powder Coated Steel Bar



9309

With Heavy-Duty Stainless Steel Bar

- vsm10153S** Three 1015 Red Lamps / HD Corrosion-Proof Stainless Steel Bar
- vsm1015A3S** Three 1015A Amber Lamps / HD Corrosion-Proof Stainless Steel Bar
- Replacement Parts: Black Powder Coated Bar vsm9313
- Stainless Steel Bar vsm9313S
- 3-plug Harness vsm9309



10353



1035A3S

1035 SERIES 2" LED IDENTIFICATION CLUSTER BARS

- Industry standard mounting holes.
- Three sealed 2" LED lamps mounted on 6" centers. Bar 16" L x 2" W.
- Includes vsm9309 3-strand harness

With Black Powder Coated Steel Bar

- vsm10353** Three 1035 Red Lamps / Black Powder Coated Steel Bar
- vsm1035A3** Three 1035A Amber Lamps / Black Powder Coated Steel Bar



9309

With Heavy-Duty Stainless Steel Bar

- vsm10353S** Three 1035 Red Lamps / HD Corrosion-Proof Stainless Steel Bar
- vsm1035A3S** Three 1035A Amber Lamps / HD Corrosion-Proof Stainless Steel Bar
- Replacement Parts: Black Powder Coated Bar vsm9313
- Stainless Steel Bar vsm9313S
- 3-plug Harness vsm9309

LED Identification Bars

LED IDENTIFICATION BAR



1505A3



15053S

1505 SERIES 2.5" LED IDENTIFICATION CLUSTER BARS

- Industry standard mounting holes.
- Three sealed 2.5" L x 1.2" W x .830 D rectangular LED lamps mounted on a cluster bar.
- Includes 9309 "3-plug harness"

With Black Permamold Bar

17.5" L x 1.5" W x 1.25" D

vsm15053 Three 1505 Red LED Lamps / Black Permamold Bar

vsm1505A3 Three 1505A Amber LED Lamps / Black Permamold Bar



9309

With Hi-polished Stainless Steel Bar

16.5" L x 1.37" W x 1.58" D

vsm15053S Three 1505 Red LED Lamps / Hi-polished Stainless Steel Bar

- Replacement Parts: Black Permamold Bar vsm9315 • Stainless Steel Bar vsm9315S
- 3-plug Harness vsm9309 • Available in Amber



1905A3



19053

1905 SERIES LED IDENTIFICATION CLUSTER BARS

- Industry standard mounting holes.
- Three sealed 3.78" L x 1.2" W x .830 D rectangular LED lamps mounted on a cluster bar.
- Includes 9339 "3-plug harness"

With Black Permamold Bar

17.5" L x 1.5" W x 1.25" D

vsm19053 Three 1905 Red LED Lamps / Black Permamold Bar

vsm1905A3 Three 1905A Amber LED Lamps / Black Permamold Bar

- Replacement Parts: Black Permamold Bar vsm9319
- 3-plug Harness vsm9339



9339



Sealed Identification Bars

Barras de Identificacion Con Luces Selladas All Lamps 12 V Standard • Red Lens Standard

INCANDESCENT BULB TYPE



1013



1013AS

1010 SERIES 2.5" IDENTIFICATION CLUSTER BARS

- Industry standard mounting holes.
- Three sealed 2.5" lamps mounted on 6" centers. Bar 16" L x 2" W x 1.25" D.
- 9309 3-plug harness.

With Black Powder Coated Steel Bar

vsm1013 Three 1010 Red Lamps / Black Powder Coated Steel Bar

vsm1013A Three 1010A Amber Lamps / Black Powder Coated Steel Bar



9309

With Heavy-Duty Stainless Steel Bar

vsm1013AS Three 1010A Amber Lamps / HD Corrosion-Proof Stainless Steel Bar

- Replacement Parts: Black Powder Coated Bar vsm9313 • Stainless Steel Bar vsm9313S
- 3-plug harness vsm9309



1033



1033AS

1030 SERIES 2" IDENTIFICATION CLUSTER BARS

- Industry standard mounting holes.
- Three sealed 2" lamps mounted on 6" centers. Bar 16" L x 2" W.
- Includes 9309 3-plug harness.

With Black Powder Coated Steel Bar

vsm1033 Three 1030 Red Lamps / Black Powder Coated Steel Bar

vsm1033A Three 1030A Amber Lamps / Black Powder Coated Steel Bar



9309

With Heavy-Duty Stainless Steel Bar

vsm1033S Three 1030 Red Lamps / HD Corrosion-Proof Stainless Steel Bar

vsm1033AS Three 1030A Amber Lamps / HD Corrosion-Proof Stainless Steel Bar

- Replacement Parts: Black Powder Coated Bar vsm9313 • Stainless Steel Bar vsm9313S
- 3-plug harness vsm9309



1503A



1503S

1500 SERIES IDENTIFICATION CLUSTER BARS

- Industry standard mounting holes.
- Three sealed 2.5" L x 1.25" W x .830 D rectangular lamps mounted on a cluster bar.
- Includes 9309 3-plug harness.

With Black Permamold Bar

17.5" L x 1.5" W x 1.25" D

vsm1503 Three 1500 Sealed Red / Black Permamold Bar

vsm1503A Three 1500A Sealed Amber Lamps / Black Permamold Bar



9309

With Hi-polished Stainless Steel Bar

16.5" L x 1.37" W x 1.58" D

vsm1503S Three 1500 Sealed Red Lamps / Hi-polished Stainless Steel Bar

vsm1503AS Three 1500A Sealed Amber Lamps / Hi-polished Stainless Steel Bar

- Replacement Parts: Black Permamold Bar vsm9315 • Stainless Steel Bar vsm9315S
- 3-plug harness vsm9309

Barras de Lamparas de Identificacion

All Lamps 12 V Standard • Red Lens Standard

SEALED INCANDESCENT BULB TYPE

1900 SERIES

SEALED IDENTIFICATION CLUSTER BARS

- Industry standard mounting holes
- Three 3.78" L x 1.2" W x .830 D rectangular sealed lamps mounted on a cluster bar
- Includes 9339 3-strand harness



With Black Permamold Bar

17.5" L x 1.5" W x 1.25" D

vsm1903 Three 1900 Sealed Red Lamps / Black Permamold Bar

vsm1903A Three 1900A Sealed Amber Lamps / Black Permamold Bar

- Replacement Parts: Black Permamold Bar vsm9319
- 3-strand Harness vsm9339



1215

1215 SERIES THREE LAMP IDENTIFICATION CLUSTER BARS

- Three dual bulb 1211 lamps mounted on an black powder coated steel bar
- Industry standard mounting holes

With White Steel Bar

17.75" L x 2.25" W x 1.50" D

vsm1216 Three 1211 Red Lamps / White Powder Coated Steel Bar

vsm1216A Three 1211A Amber Lamps / White Powder Coated Steel Bar

- Replacement Parts: Lens: Red vsm9007; Amber vsm9007A

Iluminacion Auxiliar

All Lamps 12 V Standard

PAR 36 RUBBER HOUSING LAMPS

vsm 620W Par 36, Rubber Housing Work Lamp

- With #4411 sealed beam. Serves as tractor, utility, alley or hook-up lamp for fifth wheels. All-purpose lamp in weather sealed rubber housing for long life. Protects against shock and vibration. No rust or corrosion.

- Size: 4½" diameter x 3" D, 5/16" - 18 x 1" diameter stud
- Mounting: Stud with adjustable bracket
- Replacement Parts: Rubber par 36 housing only vsm620H; Sealed Beam: #4411 12V - 35W (3,000cp)

vsm 620WV24 Par 36 Rubber Housing Work lamp

Sealed Beam: 4589 24V - 50W (5,000cp)

vsm 620A Par 36 Rubber Housing Fog lamp

Sealed Beam: 4415A 12V - 35W (7,000cp)

vsm 620WH3 Par 36 Rubber Hsg, H3 Halogen Work Lamp

With halogen bulb H3-55 watt, 12 volts

vsm 620WH3V24 With 24V H3 Halogen Work Lamp

Replacement Halogen Bulb: H3-70W-24V



620W



620A

PAR 46 RUBBER HOUSING LAMPS

vsm 630W Par 46, Rubber Work Lamp

- Size: 5¾" diameter par 46 sealed beam
- Mounting: ½" - 13 x 1 ½" mounting bolt with adjustable bracket
- Replacement Parts: Rubber par 46 housing only vsm630H Sealed Beam: #4413

vsm 630A Par 46, Rubber Fog Lamp

- Replacement Parts: Rubber par 46 housing only vsm630H Sealed Beam: #4412A 12V - 35W (8,800cp)

vsm 632W Par 46, Rubber Halogen Flood Lamp

- Replacement Parts: Sealed Beam #H7609



630W



630A

RECTANGULAR (165mm) RUBBER HOUSING LAMPS

vsm 625W7935 Rubber Housing, Halogen Spot Lamp

- Heavy duty spot lamp with 12V rectangular #7935 lamp. 175,000 CP, 50 watt all-purpose lamp in weather sealed rubber housing for long life. Protects against shock and vibration. No rust or corrosion. All mounting hardware included

- **Size:** 7¼" w x 4¾" h x 4¼" D
- Mounting: ½" diameter stud with adjustable bracket
- **Replacement Parts:** Rubber rectangular housing only vsm625H Rectangular 12V lamp: 7935 (175,000 cp, 50 watt)

vsm 625W4651 Rubber Housing Halogen High Beam Lamp

- With 50 watt, 55,000 cp, halogen bulb. 12 volts.

vsm 625H Rubber Rectangular Housing Only

- Heavy duty steel reinforced rubber housing
- Size: 7¼" w x 4¾" h x 5" D • Mounting: ½" diameter stud



625W7935

vsm 726500 4½" Chrome Plated Fog/Utility Light

- Zinc die cast housing, chrome plated finish
- 12vdc, ratchet bracket and 5/16" - 18 x 1¾" bolt
- 4½" (114mm) diameter

Replacement Sealed Beam: #4415 par 36, 12V - 35W (9,000cp)



726500

VSM615W - PAR 36 LED RUBBER HOUSING WORK LIGHT

FEATURES AND BENEFITS:

- Works perfect for the most demanding environments such as material handling, construction, agricultural, forestry, mining and other off road equipment and truck applications.
- Protects against shock and vibration.
- 8 powerful High Output LEDs.
- Multi-voltage allowed for optimum brightness.
- Includes adjustable mounting bracket and bolt.



615W

**8
HIGH OUTPUT
WHITE LEDs**

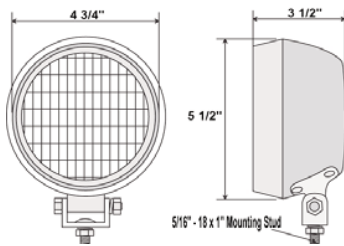

SPECIFICATIONS

- Lens - Polycarbonate, Clear Coated.
- 800 Lumens Light Output.
- Trapezoid Beam Pattern.
- Voltage 9V-36V 16.2W.
- TPR Rubber Housing.
- Light Source: 8 High Output White LEDs.

VSM665W - LED MINI WORK LIGHT

FEATURES AND BENEFITS:

- Works perfect for the most demanding environments such as material handling, construction, agricultural, forestry, mining and other off road equipment and truck applications.
- 1 SMD High-Power LED
- Ultra lightweight housing design only 170 grams.
- Multi-voltage allows optimum brightness thru all voltage ranges.
- Includes adjustable stainless steel mounting bracket and bolt.



**1 SMD
HIGH-POWER
10 WATTS LED**

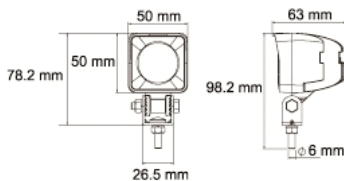

FLOOD BEAM PATTERN

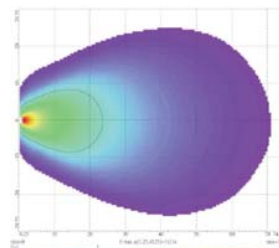

SPECIFICATIONS

- Uniform pattern without hotspots
- Ultra compact size 50mm x 50mm
- 1 SMD high power 10W LED
- 800 Lumens Light Output (2000 CD)
- Flood Beam Pattern
- Rated IP67
- Temperature -30°C to 50°C
- 18AWG 20" Cable lead wires
- Voltage 9~36VDC
- Current Draw:
12.8V @ 0.91A / 28V @ 0.42A / 36V @ 0.31A

7" LED HEADLIGHT - VSM7562D

Vehicle Safety Manufacturing is pleased to introduce its all-new **7562D** 2D1 PAR 56 replacement LED headlamp. Sold in an attractive clamshell retail package, constructed from a die-cast aluminum housing and rugged, abrasion resistant UV-protected lens, this sealed lamp provides vehicle owners with a simple way of replacing aging halogen assemblies with state of the art LED lighting technology. The built-in three-pin H4 connector allows for easy vehicle retrofitting while 9-volt to 32-volt operation covers a wide range of passenger car and truck, motorcycle and commercial vehicle applications.



Product Features

- DOT approved 2D1 Par 56 headlamp.
- Die-cast aluminum body dissipates heat buildup.
- Black powder coated finish resists corrosion.
- Impact-resistant polycarbonate lens.
- Industry-standard H4, 3-pin connector.

- Built-in high beam and low beam functionality.
- 600 lumen low beam, 1085 lumen high beam.
- 15W low beam, 27W high beam.
- 9V-32V operating voltage.
- 3 year warranty.

Product Photos



Front



Rear

LED Work Lamps with Integrated Color Camera

At *Vehicle Safety Manufacturing* we are pleased to introduce an innovative new way of illuminating and visualizing the area around your vehicle. Now available for shipment, our all-new **250-8170** and **250-8171** series of high-power LED flood beam work lamps include a high-resolution CMOS color camera and an array of eight 3-watt LEDs to provide clear visibility in the darkest environments. With their horizontal image rotation capability, these work lamp/camera combos can be utilized in a number of different positions and orientations. Our LED work lamp/camera devices are available with or without LCD monitors and since the LED lamp is powered separately from the camera, these units can serve as a standalone lighting solution, too!

Product Photos and Descriptions

Features

- ✓ Sensor: 1/3" CMOS
- ✓ Effective Pixels: 976(H) x 592(V)
- ✓ Resolution: 700 TVL
- ✓ Viewing Angle: 140°
- ✓ Minimum Illumination: 0 Lux
- ✓ Dustproof/Weatherproof: IP69
- ✓ Operating Voltage: 12 VDC
- ✓ Operating Temperature: -20°C - 70°C
- ✓ Connector: 4-Pin Thread-Together
- ✓ LED: 3-Watt x 8 (24-Watt Total)
- ✓ Lumen Output: 1154
- ✓ LED Color Temp: 6000K
- ✓ Beam Pattern: Flood
- ✓ Mounting Hardware Included



Part Number
250-8170HD



Part Number
250-8170-HD-10M
250-8170HD Camera with 10 Meter Harness

LED Work Lamps with Integrated Color Camera Continued...

Part Number 250-8170-HD-20M
250-8170HD Camera with 20 Meter Harness



Part Number 250-8220-RUL LED Work Lamp Camera, 20 Meter Harness, 7" Monitor
* 7" monitor includes pedestal stand



Part Number 250-8221-RUL LED Work Lamp Camera, 20 Meter Harness, 7" Monitor
* 7" monitor includes stem mount



Heavy-Duty Camera Systems



LED Work Lamps with Integrated Color Camera Continued...

Features

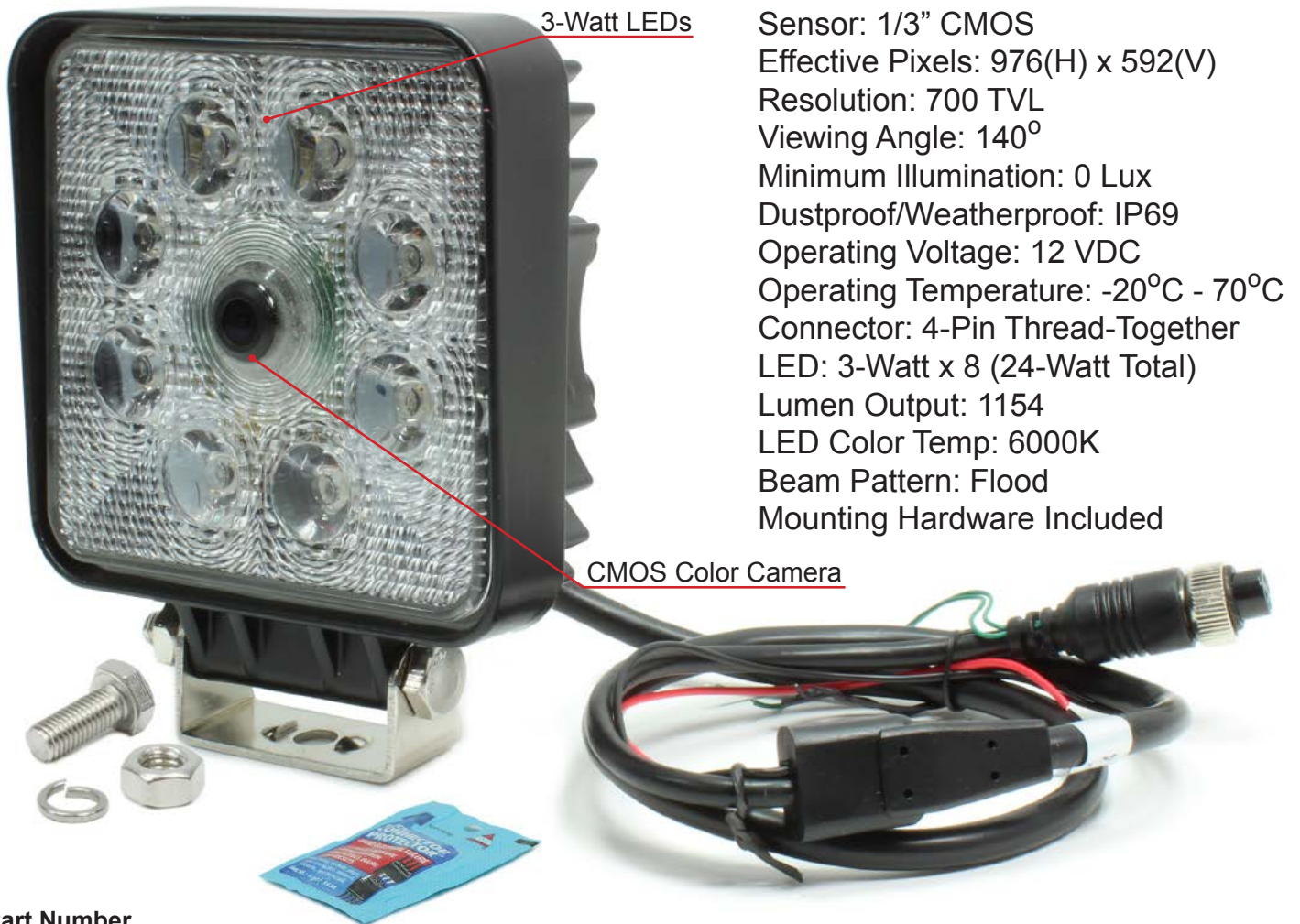

3-Watt LEDs

CMOS Color Camera

- Sensor: 1/3" CMOS
- Effective Pixels: 976(H) x 592(V)
- Resolution: 700 TVL
- Viewing Angle: 140°
- Minimum Illumination: 0 Lux
- Dustproof/Weatherproof: IP69
- Operating Voltage: 12 VDC
- Operating Temperature: -20°C - 70°C
- Connector: 4-Pin Thread-Together
- LED: 3-Watt x 8 (24-Watt Total)
- Lumen Output: 1154
- LED Color Temp: 6000K
- Beam Pattern: Flood
- Mounting Hardware Included

Part Number
250-8171HD

Part Number 250-8171-HD-10M
250-8171HD Camera with 10 Meter Harness



LED Work Lamps with Integrated Color Camera Continued...

Part Number 250-8171-HD-20M
250-8171HD Camera with 20 Meter Harness



Part Number 250-8220-SUL LED Work Lamp Camera, 20 Meter Harness, 7" Monitor
* 7" monitor includes pedestal stand



Part Number 250-8221-SUL LED Work Lamp Camera, 20 Meter Harness, 7" Monitor
* 7" monitor includes stem mount



Magnetic Mounting Base for LED Lamps and Cameras

Vehicle Safety Manufacturing is pleased to introduce an innovative new way of attaching our recently-released combination LED work lamp cameras to your vehicle. Available for immediate shipment, VSM part number **250-8170-MAG** is a 3.5" rubber-coated disk which incorporates 12 powerful magnets into its base to temporarily or permanently attach an LED lamp or other hinge-mount camera to a metal body panel.



Product Photos

Lamp Mounting Bracket and Nut
Included with VSM Lamps





Trailer Camera Connectors



VSM is excited to announce the availability of all-new multi-camera integration systems for drivers that tow a trailer on a regular basis and long for added visibility behind, to the side of, in front of, and even inside of the trailer connected to the vehicle.

Now available for immediate purchase, Rostra's camera systems raise the bar in terms of build quality, affordability, and long-term dependability over currently-available competitive products. Have a look at these key features that distinguish Rostra from the rest of the industry:

Product Features

8mm Reinforced Coil Cables

Others Use 4mm

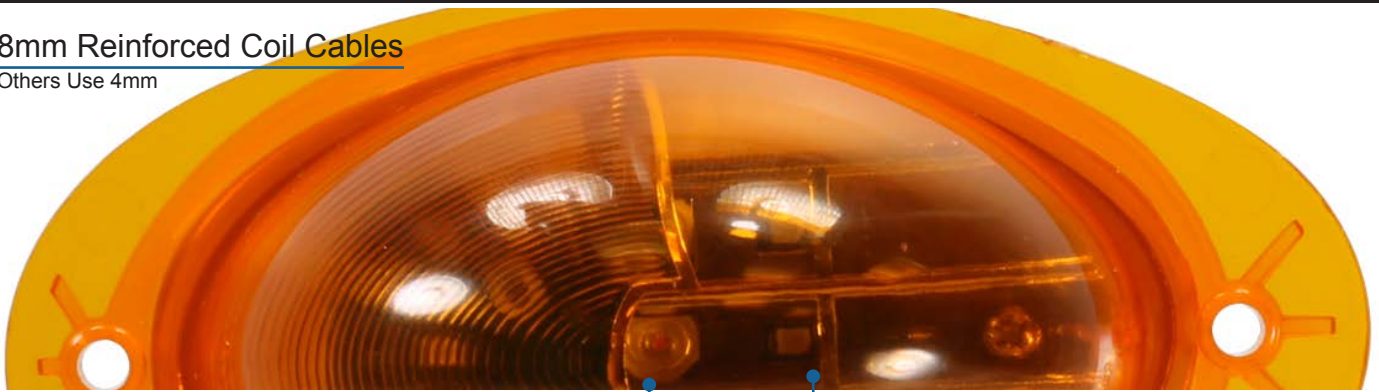

Thread-Sealed Weatherproof Connectors

Others Use Push-Together Friction Fittings

Polished, Hardened Connection Points

Others Use Lightweight Molded Aluminum

Heavy-Duty Copper Pins for Positive Contact



Provision for One Camera with Audio Feed

Others Offer No Audio Capability In Their Harnesses



Trailer Camera Connectors



250-8721-KIT

One-Camera Trailer Connection Kit with 5-Pin 2.5 Meter (8.2') Coil Harness and 10-Meter (33') Vehicle Harness



250-8722-KIT

Two-Camera Trailer Connection Kit with 5-Pin 2.5 Meter (8.2') Coil Harness and 10-Meter (33') Vehicle Harness



250-8723-KIT

Three-Camera Trailer Connection Kit with 7-Pin 2.5 Meter (8.2') Coil Harness and 10-Meter (33') Vehicle Harness



250-8724-KIT

Four-Camera Trailer Connection Kit with 7-Pin 2.5 Meter (8.2') Coil Harness and 10-Meter (33') Vehicle Harness





Trailer Camera Connectors

Trailer Camera Service Components

VSM offers a complete line of service components so that fleet managers and vehicle owners can mix and match this equipment to meet their custom trailer camera needs.

250-8721-COIL4M

5-Pin 4 Meter (13.1') Coil Harness



250-8723-COIL4M

7-Pin 4 Meter (13.1') Coil Harness



250-8721-COIL

5-Pin 2.5 Meter (8.2') Coil Harness

For use with 250-8721/250-8722 Kits



250-8723-COIL

7-Pin 2.5 Meter (8.2') Coil Harness

For use with 250-8723/250-8724 Kits



250-8721-TRL



250-8721-TOW



250-8722-TRL



250-8722-TOW



250-8723-TRL



250-8723-TOW



250-8724-TRL



250-8724-TOW



250-8617

5-Meter Extension



250-8921

10-Meter Extension



250-8615

20-Meter Extension



Side-View Mirror-Camera



Now available, part number **250-8185** is designed for use on side-mounted applications but is versatile enough to adapt to mounting in almost any orientation and includes brackets for use with 1" to 1.5" diameter side mirror arms. Combined with its 120-degree viewing angle, the camera's ability to both swivel 360-degrees around in its housing as well as up, down, left and right to adjust the vertical and horizontal view, this camera is the ideal solution for fleet managers to use across their entire line of vehicles.

Product Features

Sensor: 1/3" Sony CCD

Resolution: 700 TVL 976x582

TV System: NTSC

Illumination: 0 LUX with IR Assist

View Angle: 120-Degree

Image: Mirror View

Housing: Aluminum

IP Rating: IP67/IP68

Shock Proof: 4G

Operating Voltage: 12 VDC

Connector: 4-Pin Aviation

Cable/Pigtail Length: 16"

Operating Temperature: -30°C to 70°C

Storage Temperature: -45°C to 85°C

The **250-8185** camera includes a bracket for use with 1" to 1.5" diameter side mirror arms. The bracket and its included hardware conveniently wrap around and then tighten down to the mirror arm for a stable, secure attachment point. The included rubber pads sandwich between the bracket itself and the mirror arm providing both shock absorption and preventing metal-to-metal contact between the camera and the polished or painted surface of the mirror arm.

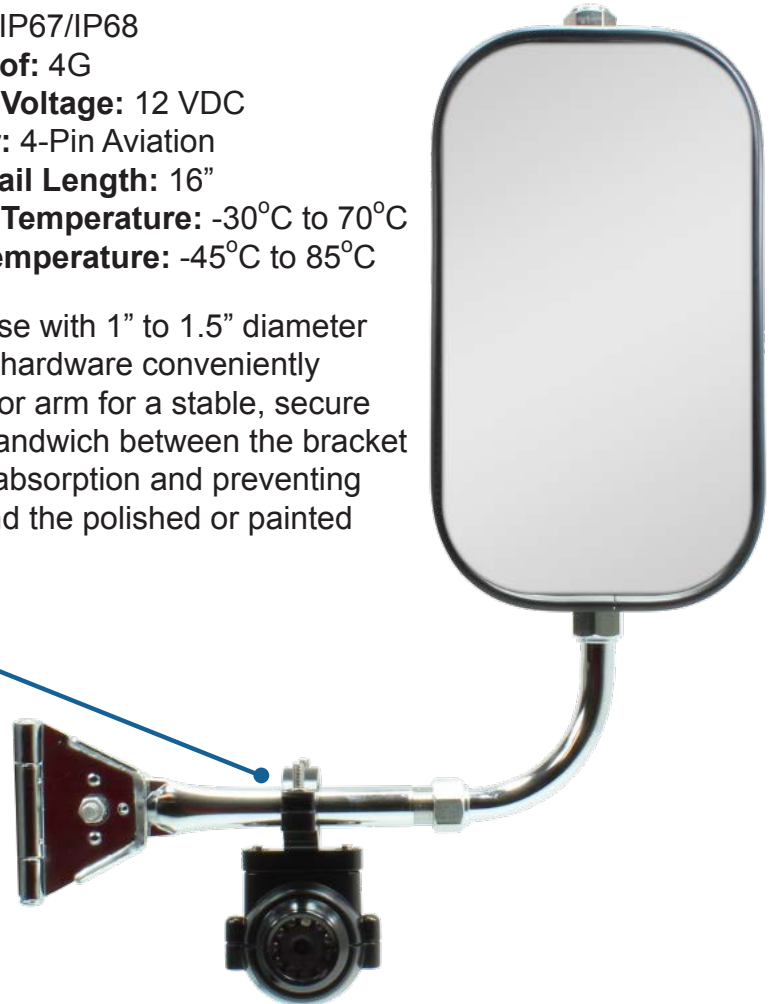

Product Photos



Stainless Steel Infrared Hinge-Mount CMOS Color Camera

- 250-8098-20M** 250-8098 Camera, 20-Meter Harness, Power/Ground/Video Harnesses
- 250-8098-10M** 250-8098 Camera, 10-Meter Harness, Power/Ground/Video Harnesses
- 250-8098** 250-8098 Camera with Pigtail Only



Dome Style Surface-Mount CMOS Color Camera

- 250-8143-20M** 250-8143 Camera, 20-Meter Harness, Power/Ground/Video Harnesses
- 250-8143-10M** 250-8143 Camera, 10-Meter Harness, Power/Ground/Video Harnesses
- 250-8143** 250-8143 Camera with Pigtail Only

Pictured: 250-8143-20M



Hinge-Mount Infrared CMOS Color Camera (Black Exterior)

- 250-8150-20M** 250-8150 Camera, 20-Meter Harness, Power/Ground/Video Harnesses
- 250-8150-10M** 250-8150 Camera, 10-Meter Harness, Power/Ground/Video Harnesses
- 250-8150** 250-8150 Camera with Pigtail Only

Pictured: 250-8150-20M



Hinge-Mount Infrared CMOS Color Camera (White Exterior)

- 250-8149-20M** 250-8149 Camera, 20-Meter Harness, Power/Ground/Video Harnesses
- 250-8149-10M** 250-8149 Camera, 10-Meter Harness, Power/Ground/Video Harnesses
- 250-8149** 250-8149 Camera with Pigtail Only

Pictured: 250-8149-20M



Multi-Channel Video Monitors



Part Number
250-8290

Specifications

Screen Size: 9 Inches
Aspect Ratio: 16:9
Luminance: 250cd/m²
Resolution: 800x480
Audio: 1 Audio Input
Built-In Speaker: Yes

Video: 4 Video Inputs
Video System: PAL/NTSC
Bracket: 1 U-Type Bracket Included
Sunshade: Included/Removable
Operating Voltage: 12-24 VDC
Modes: Full, 2 Split, 3 Split, 4 Split

System Language: English, French, Spanish, Dutch, Portuguese, Italian, Turkish, Chinese
OSD Menu: Selects Picture, Volume, Mirror Image, Language, Delay

Part Number
250-8222 7" LCD, 4 Video Inputs



Available with windshield mount stem as part number 250-8223

Part Number
250-8220 7" LCD, 2 Video Inputs



Available with windshield mount stem as part number 250-8221



VSM635W

High Output LED Work Lamp

Features and Benefits:



- Vehicle Safety Manufacturing's new **635W** is built for the most demanding work environments including material handling, construction, agriculture forestry, mining and other off-road equipment and truck applications.
- Life of 30,000+ hours means no more replacing broken bulbs.
- Emits clear white light output to illuminate your work areas and equipment.
- Waterproof sealed design with a rugged die cast metal housing protects the LEDs from vibration and moisture.
- 10 diode pattern, 900 lumens.
- Black powder coated aluminum die cast housing is compact and stylish.
- Lamp size 4 1/2" H x 1 1/2" D.
- 18 AWG, 20" cable lead wires.
- Lamp operates at full brightness between 9-36 VDC, allows for multi-voltage applications.
- Low current draw 1.3 Amp @ 12.8V.
- Includes adjustable stainless steel mounting bracket and bolt.

VSM645W High Output LED Work Lamp

Features and Benefits:

- Vehicle Safety Manufacturing's new **645W** is built for the most demanding work environments including material handling, construction, agriculture forestry, mining and other off-road equipment and truck applications.
- Life of 30,000+ hours means no more replacing broken bulbs.
- Emits clear white light output to illuminate your work areas and equipment.
- Waterproof sealed design with a rugged die cast metal housing protects the LEDs from vibration and moisture.
- 8 diode pattern, 700 lumens.
- Black powder coated aluminum die cast housing is compact and stylish.
- Lamp size 4 3/8" L x 4 7/8" H x 1 7/8" D.
- 18 AWG, 20" cable lead wires.
- Lamp operates at full brightness between 9-36 VDC, allows for multi-voltage applications.
- Low current draw 1.3 Amp @ 12.8V.
- Includes adjustable stainless steel mounting bracket and bolt.



Aluminum die cast housing

Polycarbonate Lens

Stainless Bracket/Bolt

18 AWG, 20" Pigtail

Thin Profile



VSM655W High Output LED Work Lamp

Features and Benefits:



- Vehicle Safety Manufacturing's new **655W** is built for the most demanding work environments including material handling, construction, agriculture forestry, mining and other off-road equipment and truck applications.
- Life of 30,000+ hours means no more replacing broken bulbs.
- Emits clear white light output to illuminate your work areas and equipment.
- Waterproof sealed design with a rugged die cast metal housing protects the LEDs from vibration and moisture.
- 8 diode pattern, 900 lumens.
- Black powder coated aluminum die cast housing is compact and stylish.
- Lamp size 4 3/8" L x 3 7/8" H x 1 7/8" D.
- 18 AWG, 20" cable lead wires.
- Lamp operates at full brightness between 9-36 VDC, allows for multi-voltage applications.
- Low current draw 1.3 Amp @ 12.8V.
- Includes adjustable stainless steel mounting bracket and bolt.

Auxiliary Lighting



Vehicle Safety Manufacturing is pleased to introduce the latest in its growing line of LED work lamps. Now available for shipment, part number **VSM643W** is a multifunctional cube-shaped lamp with four 3-watt diodes that emit light in a spot beam pattern for greater visibility at long distances. Every VSM643W includes one lamp with 12-inch pigtail and integrated DEUTSCH sealed connector, swivel mounting bracket, rubber base insulator, and stainless steel fasteners.

Features

LED Power: 12-Watts

LED Type: 4 x 3-Watt Osram LED

LED Lifespan: 30,000 Hours

Lumen Output: 1080 Lumen

LUX: 380 LUX at 10M

Operating Voltage: 10-30V DC

Color Temperature: 6000K

Beam Pattern: Spot Beam (8-Degree)

Current Draw: 1.0A at 12V, .5A at 24V

Waterproof Rating: IP67

Housing Material: Diecast Aluminum

Lens Material: Polycarbonate

Certificates: CE/IP69K/RoHS/IP67/Emark

Harness: VSM96951* (single), VSM96952* (dual)

* sold separately

Kit Components



Assembled Lamp



Vehicle Safety Manufacturing is pleased to introduce a new exterior flood lamp assembly for use with heavy-duty applications requiring best in class visibility from a small form factor. Now available for shipment, part number **VSM663W** is a multifunctional lamp that can mount directly to any surface using the included flat or curved rubber base mounts providing superior illumination on demand. IP67 weatherproofing along with an operating temperature of -20°C to +50°C means this lamp is sure to perform in the harshest environments.



VSM663W

Features

Lamp Power: 15-Watts

LED Type: 3 x 5-Watt Cree LED

Light Color: White

Raw Lumen Output: 1260 Lumen

Operating Voltage: 10-30V DC

Current Draw: 0.3 - 0.16A

Beam Pattern: Flood Beam (120-Degree)

Waterproof Rating: IP67

Body Color: Black

Lens Material: Polycarbonate

Kit Components

VSM663W lamp with pigtail



Rubber Mounting Base (flat)

Rubber Mounting Base (curved)

Bar-Style Work Lamps



Vehicle Safety Manufacturing is pleased to introduce three great new additions to its line of bar-style LED work lamps. Now available for shipment, VSM is excited to deliver part numbers **VSM69508W** (8" length), **VSM69514W** (14" length), and **VSM69522W** (22" length). Intense illumination paired with rugged build quality make these work lamps the ideal solution for heavy-duty applications working in the toughest environments.

LED Work Lights

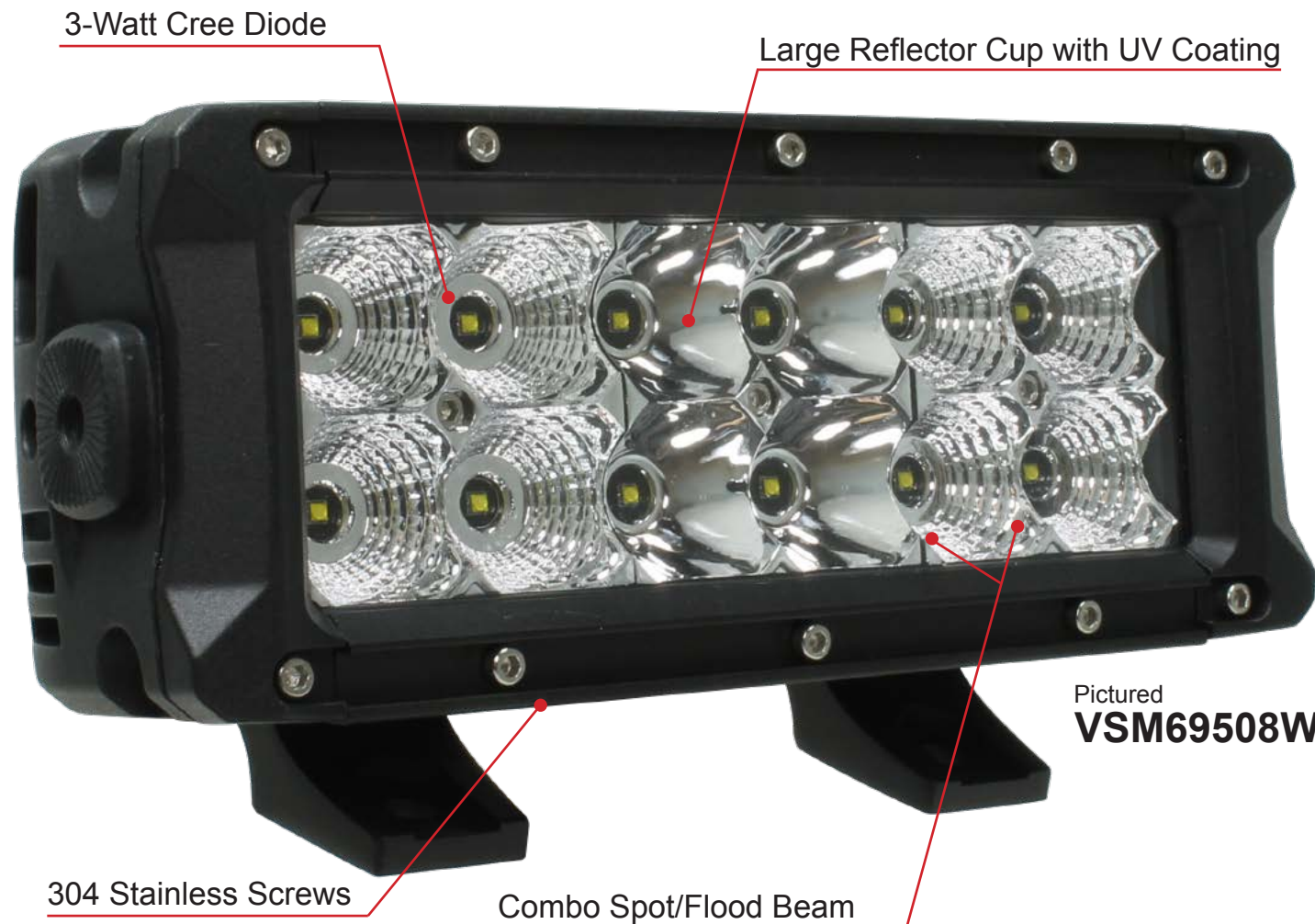

Pictured
VSM69508W

Features and Specifications

Lamp Power: Various
LED Type: 3-Watt Cree Diodes
Color Temperature: 6000K
Raw Lumen Output: Various
Operating Voltage: 10-30V DC

Body Color: Black
Housing: Diecast Aluminum
Mounting Bracket: Aluminum Alloy
Beam Options: Spot (8°), Flood (90°)
Operating Voltage: 10-30V DC

Included Components



Pictured **VSM69514W**



Gore Breather

Slim, Diecast Aluminum Housing

Secure Mounting

Wire Harness Options

Every VSM LED work lamp includes a wire harness extension with DUETSCH DT connector and positive and negative wire leads. This harness is ideal for tying into preexisting electrical wiring, but VSM also offers two plug-and-play extended length wire harnesses with an illuminated two-position control switch, relay, in-line 30 amp fuse and single or dual DUETSCH DT connectors for custom installations. See below...



VSM Universal Work Lamps Wire Harnesses (Sold Separately)

VSM96951



Wire harness with single DUETSCH DT connector.
9.5' from relay to DEUTSCH DT connectors.
6.3' from relay to control switch.

VSM96952



Wire harness with dual DUETSCH DT connector.
9.5' from relay to DEUTSCH DT connectors.
6.3' from relay to control switch.

All Lamps 12-Volt Standard

Iluminacion Auxiliar

Specifications

VSM4411LED converts any PAR 36 incandescent lamp into a solid state LED work light. With standard connections, users can upgrade an existing incandescent or halogen sealed beam lamp, converting it into a super-bright LED work light that lasts longer, shines brighter and delivers better value - all without removing the original fixture from the vehicle.



Features and Benefits

- Built to last in the most demanding environments such as material handling, construction, agricultural, forestry, mining and other off road equipment and truck applications.
- Threaded mounting holes on back of housing allow lamp to be mounted as stand alone device.
- Push on terminals makes conversion quick and easy.
- Trapezoid Beam pattern.
- Lamp operates at full brightness between 9-36 VDC, allows for multi-voltage applications.
- Waterproof sealed design with a rugged die cast metal housing that protects the LEDs from vibration and moisture.



Specifications

- Polycarbonate lens with clear hard coat.
- Black powder coated aluminum die cast housing.
- 800 Lumens light output.
- 8 Powerful high output LEDs.
- Voltage 9V-36V.
- Aluminum PCB.
- Current draw 1.14 Amps @ 12.8 VDC.

Trapezoid Beam Pattern

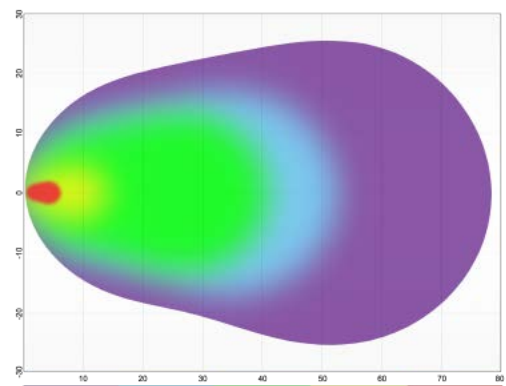

All Lamps 12-Volt Standard

Iluminacion Auxiliar

Specifications

VSM4415LED converts any PAR 36 incandescent lamp into a solid state LED work light. With standard connections, users can upgrade an existing incandescent or halogen sealed beam lamp, converting it into a super-bright LED work light that lasts longer, shines brighter and delivers better value - all without removing the original fixture from the vehicle.



Features and Benefits



- Built to last in the most demanding environments such as material handling, construction, agricultural, forestry, mining and other off road equipment and truck applications.
- Threaded mounting holes on back of housing allow lamp to be mounted as stand alone device.
- Push on terminals makes conversion quick and easy.
- Trapezoid Beam pattern.
- Lamp operates at full brightness between 9-36 VDC, allows for multi-voltage applications.
- Waterproof sealed design with a rugged die cast metal housing that protects the LEDs from vibration and moisture.

Specifications

- Polycarbonate lens with clear hard coat.
- Black powder coated aluminum die cast housing.
- 800 Lumens light output.
- 8 Powerful high output LEDs.
- Voltage 9V-36V.
- Aluminum PCB.
- Current draw 1.14 Amps @ 12.8 VDC.

Spot Beam Pattern

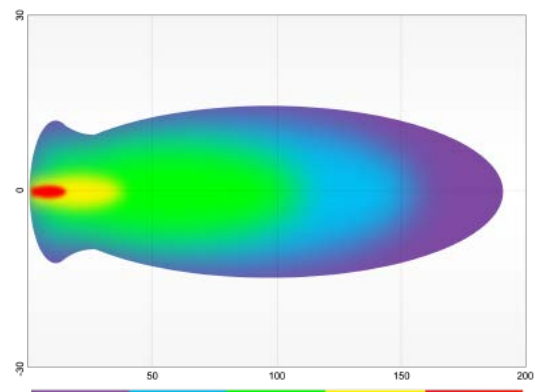



6064W

vsm6064W Sealed Oval Back-Up lamp

- White lens
- Double contact
- Polycarbonate lens and housing
- Suitable for vertical or horizontal orientation
- Use 9128 plug and 9526 grommet



6464W

vsm6054W Sealed Back-Up Lamp Kit

The 6064W lamp with kit consisting of the 9128 plug and 9526 grommet

vsm6464W Sealed LED Auxiliary Lamp

- 10 diode white oval lamp with clear lens for auxiliary applications
- Sealed polycarbonate lens and housing
- Use VSM9526 grommet and PL3 pigtail connection

10
SMD
DIODES



4211W

vsm4211W Black Metal Housing - Flush Mount

- Snap-ring lens • Size: 5 " diameter, 2" depth under flange,
- Mounting: Mounts through 4.5" diameter cutout with three #10 screws on 4.93" diameter bolt circle
- Rpl. Parts: Lens vsm9031CX • Snap ring vsm9039 • Bulb #1156



9362W



9362WT

6
SMD
DIODES

vsm9362W LED Interior Dome Lamp

vsm9362WT LED Interior Dome Lamp with Touch Switch

- Ultra slim profile • Surface mounting design • Clear Lens
- Size: 2.95" O.D x 0.34" H • Mounts with 2 # 8 screws on 2.32" centers
- 6 SMD White LEDs
- Voltage: 12/24V



9369W



9369WT

15
SMD
DIODES

vsm9369W LED Interior Dome Lamp

vsm9369WT LED Interior Dome Lamp with Touch Switch

- Ultra slim profile • Surface mounting design • Frosted Lens
- Size: 9.23" L x 4.92" W x 0.51" H
- Mounts with 2 # 8 screws on 7.87" centers
- 15 SMD White LEDs
- Voltage: 12/24V



9367SW

vsm9367SW Dome Light with Switch

vsm9367W Dome Light without Switch

- Flange-less model, Twist-off lens, • Nylon washer for single wire pigtail
- Size: 5.5" O.D x 1.46" H
- Mounting: Three 0.20" mounting holes on a 5.98" circle
- Bulb #1141



Backup, Utility Lamps

Back-Up, Utility Lamps

All Lamps 12-Volt Standard

Lamparas de Utilidad

- VSM44631W** 4" Round LED Back Up Lamp
 - 10 SMD LED Pattern
 - Clear Lens with Interior Chrome Reflector
 - Voltage / Amp : 12.8V - .22Amp
 - Mounting: Through 4.5" Diameter Hole
 - Use VSM9127 Grommet Mount, VSM9123 Pigtail



- VSM4054C** 4" Round Utility Lamp Kit with Clear Lens
- VSM4054W** 4" Round Backup Lamp Kit with White Lens
 - Clear or White Lens, Double Contact
 - Size: 4 3/8" Diameter x 2" Depth Under Grommet Flange
 - Mounting: Through 4.5" Diameter Hole
 - Use VSM9127 Grommet Mount, VSM9123 Pigtail



- VSM4064C** 4" Round Utility Lamp with Clear Lens
- VSM4064W** 4" Round Backup Lamp with White Lens
- VSM4464W** 4" Round Auxiliary Lamp
 - 10 Diode White Lamp with Clear Lens for Auxiliary Applications
 - Use Industry-Standard Grommet and Pigtail Connections

- VSM4063C** Sealed 4" Round Utility Lamp with Clear Lens
- VSM4063W** Sealed 4" Round Utility Lamp with White Lens
 - Clear or White Lens, Single Contact
 - Size: 4 3/8" Diameter x 2" Depth Under Grommet Flange
 - Mounting: Through 4.5" Diameter Hole
 - Use VSM9127 Grommet Mount, VSM9123 Pigtail



- VSM4463W** 4" Round Clear LED Back Up Lamp
 - 36 LED Pattern
 - Voltage / Amp : 12.8V - .22Amp
 - Mounting: Through 4.5" Diameter Hole
 - Use VSM9127 Grommet Mount, VSM9123 Pigtail



License Plate Lamps/Brackets



VSM420W

Standard License Plate Lamp

- Size: 2⁵/₈" Diameter x 1⁵/₈" W x 2" D
- Mounting: Two #10 Screws on 1³/₄" Centers

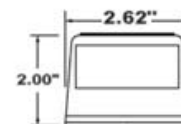

Replacement Parts

- Cover and Lens - VSM9055W
- Bulb - 168

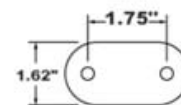

VSM430W

Chrome License Plate Lamp

For use as license plate illuminator as well as step, courtesy and instrument illuminator. General purpose.

- Size: 1¹/₂" Diameter x 1¹/₂" Depth (Under Flange)
- Mounting: 1¹/₄" Hole Through .060 - .250 Thick Panel
- Replacement Bulb 67



VSM431W

Steel Chrome License Plate Lamp

- Heavy Duty Chrome-Plates Steel Housing
- Size: 2³/₄" L x 1¹/₂" W x 2¹/₄" D
- Mounting: Uses Two 1¹/₄" Screws on 2" Centers
- Replacement Bulb 67



VSM1502W

VSM1502W

Sealed One-Bulb License Lamp

- 15,000 Hour Rates Bulb Life
- Requires 15729 Base for Mounting
- Polycarbonate Lens and Housing

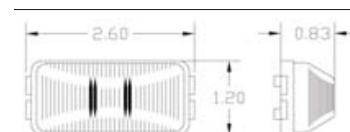

VSM1901W

VSM1901W

Sealed Two-Bulb License Lamp

- Polycarbonate Lens and Housing
- Requires 9389 Base for Mounting



VSM426W

VSM426W

License Light with Black Steel Bracket

- 2 Wire Design
- Stainless Steel Mounting Base
- Polycarbonate with Grey ABS Hood
- Replacement Bulb 168
- Voltage/Amp: 14V/0.35 Amp

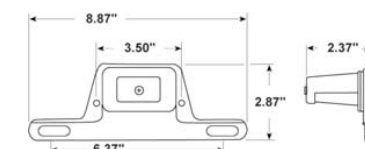



Luces de Matricula

All Lamps 12-Volt Standard

License Plate Lamps/Brackets

VSM437 License Plate Lamp (Black Finish)

VSM438 License Plate Lamp (Chrome Finish)

High-impact plastic body with steel base, acrylic lens, stainless steel and nylon pigtail, stainless screws and rubber gasket. Uses 67 bulb.

- Size: 4 1/8" L x 3 7/16" H x 2 3/16" D
- Mounting: Two 1/4" Mounting Holes on 3 5/8" Centers



VSM15011 Grey License Lamp Mounting Bracket

Grey, high-impact polycarbonate bracket complete with VSM1502W lamp and VSM9122 pigtail.

VSM15012 Black License Lamp Mounting Bracket

Black, high-impact polycarbonate bracket complete with VSM1502W lamp and VSM9122 pigtail.



VSM15511 Grey License LED Lamp Mounting Bracket Kit

Grey, high-impact polycarbonate bracket complete with VSM1515W LED lamp with hard-wired leads and .156" diameter insulated female receptacles.

VSM15512 Black License LED Lamp Mounting Bracket Kit

Black, high-impact polycarbonate bracket complete with VSM1515W LED lamp with hard-wired leads and .156" diameter insulated female receptacles.



VSM15729 Grey License Lamp Mounting Bracket

Grey, high-impact polycarbonate bracket with snap-in lamp mount. Use with 1500-series license lamps.

VSM15730 Black License Lamp Mounting Bracket

Black, high-impact polycarbonate bracket with snap-in lamp mount. Use with 1500-series license lamps.



VSM15729

License Plate Lamps/Brackets



VSM310A

High-Profile 360° Strobe Warning Lights

- 6.75" diameter aluminum base, diode protected.
- 6.25" amber high-profile lens.
- SAE-J1318, SAE-Class 1 and 2.
- Epoxy coated electronics protect against excessive moisture and vibration.
- 15 Joules Quad Flash
- 12-24 VDC

High-Profile 360° LED Strobe Warning Lights

- 24 LEDs per head (replaceable).
- 12-48 VDC.
- Current Draw: .8 Amp Max @ 12VDC / .3 Amp @ 48VDC.
- 11 different flash patterns: Quad (4fpm), Rapid (120fpm), Double (80fpm), Single Slow Flash (60fpm), Quint Flash (80fpm), Single (80fpm).



VSM310AM

VSM310A High-Profile Permanent Mount Strobe Warning Lamp

Mounting: Permanent mount with 1" pipe mount standard

VSM310AD High-Profile Permanent Mount Strobe Warning Lamp

Mounting: Permanent mount with 1" pipe mount standard

Includes VSM9340W Cover

VSM310AM High-Profile Magnetic Mount Strobe Warning Lamp

Mounting: Magnetic mount with cigarette lighter adapter

Replacement Parts for High-Profile 310/315 Series Strobes

- VSM9113A** Amber High-Profile Lens
- VSM9340W** Clear High-Profile Dust Cover
- VSM88310** Quad Flash Tube
- VSM88315** Quad LED Strobe Tube



VSM9113A



VSM9340W



VSM88310



VSM310ALP

Low-Profile 360° Strobe Warning Lights

- 6.75" diameter aluminum base, diode protected.
- 4.5" amber low-profile lens.
- SAE-J1318, SAE-Class 1 and 2.
- Epoxy coated electronics protect against excessive moisture and vibration.
- 15 Joules Quad Flash
- 12-24 VDC

VSM310ALP Low-Profile Permanent Mount Strobe Light

Mounting: Permanent mount with 1" pipe mount standard

VSM310ALPM Low-Profile 360° Magnetic Mount Strobe Lamp

Mounting: Magnetic mount with cigarette lighter adapter

Replacement Parts for Low-Profile 310 Series Strobes

- VSM9113A** Amber High-Profile Lens
- VSM88310** Quad Flash Tube



VSM310ALPM



VSM9113AL



VSM88310



VSM303A

Rubber Base Strobe Warning Light

VSM303A Double Flash Rubber Base Strobe Light

Mounting: Rubber base, permanent mount

- 4" diameter from center to center. 4 5/8" H amber low-profile lens.
- Diode protected.
- SAE-J1318, SAE-Class 3.
- 2.5 Joules Double Flash. 12-48 VDC.



Luces de Advertencia & Emergencia

All Lamps 12-Volt Standard

Multi-Voltage Strobe Warning Lights

- 5" diameter ABS base with 3-hole metal ring.
- 3 5/8" low-profile.
- Diode protected.
- SAE - J 1318, Class 3, SAE-UL and CE approved.
- 2 Joules, Single Flash.
- 12-80 VDC.

VSM307A



VSM307A Multi-Voltage Permanent Mount Strobe Light

Also available in LED (VSM307ALED)

Mounting: Permanent mount

VSM313A Multi-Voltage Magnetic Mount Strobe Light

Mounting: Magnetic mount with cigarette plug kit



VSM313A

Replacement Parts for Multi-Voltage Strobes

VSM9374A Amber Low-Profile Dome Lens

VSM88307 Flash Tube



VSM9374A

Multi-Voltage Strobe Warning Light

VSM306A Multi-Voltage Compact Industrial Strobe Light

Also available in LED (VSM306ALED)

- Compact strobe ideal for material handling market.
- 5" H x 2 3/4" base diameter.
- Mounting #10 screws on 3 3/8" centers
- Flash Rate: 72 FPM 2 Joules, Single Flash
- 12-120 VDC / 0.24 Amp
- Polycarbonate Base and Dome provide excellent durability.



LED Self-Contained Strobe Warning Light

VSM46644A 4" Round LED Quad Flash Strobe Light

- Lamp Dimensions: 4 1/4" Diameter x 1 3/4" Height.
- 9-36 VDC, 0.39 Amp Quad Flash
- 24 Superflux high-output LEDs
- Polycarbonate lens and housing.
- SAE J845 Class 2 on 12V applications.
- Uses regular open or closed back grommets and double-contact pigtailed.



VSM66644A 6" Oval LED Quad Flash Strobe Light

- Lamp Dimensions: 6 1/2" L x 2 1/4" H x 1 3/4" H.
- 9-36 VDC, 0.38 Amp Quad Flash
- 24 Superflux high-output LEDs
- Polycarbonate lens and housing.
- SAE J845 Class 2 on 12V applications.
- Uses regular open or closed back grommets and double-contact pigtailed.



VSM69644A 6" Oval LED Arrow Sequential Warning Light

- Lamp Dimensions: 6 1/2" L x 2 1/4" H x 1 7/8" H.
- 9-36 VDC, 0.38 Amp Quad Flash
- 35 Superflux high-output LEDs
- Polycarbonate lens and housing.
- SAE J845 Class 2 on 12V applications.
- Used as auxiliary mid-turn signal and warning light
- Arrow sequential moving pattern or steady on.
- Uses regular open or closed back grommets and double-contact pigtailed.



LED Warning Lamps



Portable Warning Lamps

All Lamps 12-Volt Standard

Luces de Advertencia/Emergencia

VSM's LED compact warning lights are great for the following applications:

- Trucking Companies
- Utility and Service Vehicles
- Emergency Management Services
- Law Enforcement
- Fire Departments
- Highway Departments
- Construction Contractors
- Roadside Emergency Signal - Stalled Or Disabled
- Temporary Barricade - Highway Detour, Accident Site, Utility Work, Traffic Obstructions, Crime Scenes, Etc.
- Marine Use - Locator Signal On Buoys / Floats
- Agricultural Use - Marker For Farm Vehicles On Public Roads

Features and Benefits

- Dual Functions – Flashing and Steady Signal
- Super Bright LEDs
- Visible Up To 1.3 Miles
- Magnetic Backing Attaches To Metal Surfaces
- Bracket Mounting With Screws
- Slide Out Stanchion – Self Supporting Stand*
- Weather Resistant Design
- Compact Size
- Completely Portable
- Non Hazardous Environmentally Friendly Alternative To Safety Flares

VSM4500AK

Amber Warning Light with Mounting Bracket



VSM4500K

Red Warning Light with Mounting Bracket



VSM4500AM

Amber Warning Light, Magnet Base

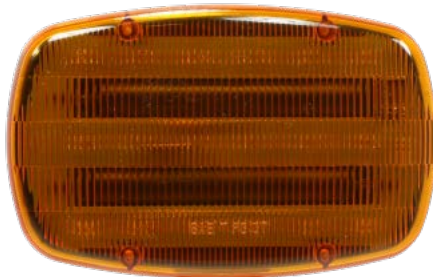

VSM4500M

Red Warning Light, Magnet Base



4500AM, 4500M Magnet Base



Specifications

- 6 3/8" L x 4" W x 1 3/4"H
- Requires 4 (1.5V) AA Batteries
- Net weight (6.72 oz) (Without Batteries)



Universal Trailer Light Kit

Universal, Submersible LED Trailer Light Kit

VSM5551DK PRODUCT FEATURES

- Long-life high visibility LED stop/tail/turn lamps.
- LED side marker lamps with amber cover included.
- Universal license plate mounting bracket included.
- License plate illumination lamp on driver-side tail lamp.
- Submersible sealed tail lights ideal for boat trailers.
- Full-color clamshell retail packaging with UPC label.
- Full-color installation instruction in package.
- Color-coded wiring harness for easy identification.
- Includes trailer-length extension wiring harness and harness clips.
- Includes trunk/tailgate wiring harness to connect to vehicle lamps.
- Trailer and vehicle harness include universal 4-pin connector.
- Weatherproof heat shrink butt connectors included.
- Mounting studs and nuts are included for installation on trailer.

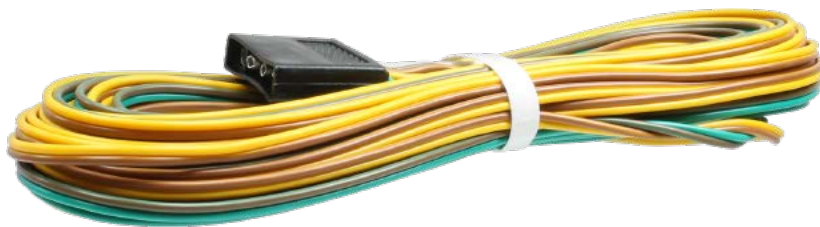

Pigtails/Plug Connectors

VSM9122 Molded 2-Prong Plug Connector

Plug connector for sealed 2" and 2 1/2" round and VSM1500 series incandescent and LED lamps



VSM9122

VSM9122Y106 Multiple 2-Prong Plug Connector Harness

Coiled harness with 100 VSM9122 2-prong plugs mounted on 6" centers

VSM9122Y110 Multiple 2-Prong Plug Connector Harness

Coiled harness with 100 VSM9122 2-prong plugs mounted on 10" centers

VSM9122Y112 Multiple 2-Prong Plug Connector Harness

Coiled harness with 100 VSM9122 2-prong plugs mounted on 12" centers



VSM9123 Molded Rubber Plug for Single Contact Lamps

Plug for single contact lamps with ground wire

VSM9124 Molded Rubber Plug for Double Contact Lamps

Plug for double contact lamps with ground wire

Plug connector for VSM4000 and 6000 series sealed incandescent and LED lamps



VSM9123



VSM9124

VSM9128 Molded Right Angle Plug

3-wire, 90-degree plug-in pigtail for VSM4000 and 6000 series sealed incandescent and LED lamps with stop, tail, turn function

VSM9130 Molded Right Angle Tail Plug

2-wire, 90-degree plug-in pigtail for VSM4000 and 6000 series sealed incandescent and LED lamps with auxiliary tail function



VSM9128



VSM9130

VSM9170 Female Bullet Plug

Single .180 female bullet plug with 10" wire length



VSM9170

VSM9170Y116 Female Bullet Plug

Coiled harness with 100 VSM9170 female bullet plugs mounted on 16" centers



VSM9170Y116

VSM9221 Hot Wire

For VSM2100 series sealed incandescent and LED lamps

VSM9256 Hot Wire

For VSM1900 series sealed incandescent and LED lamps



VSM9221

VSM9256

VSM9444 Electronic Flasher Strobe Module

- Converts an LED lamp into strobe lamp
- 9-16 VDC, Max 15 Amps
- Continuous hyper strobe 850 FPM flash rate
- Designed for use in a flashing circuit with a vehicle flasher controlling the rate of flashes per minute.

VSM9446 LED Strobe Flasher Module

- SAE J595 6 Pulse Flash/Pause Strobe Pattern
- 9-16 VDC, Max 15 Amps
- Converts an LED lamp into flash/strobe lamp
- Operate up to 40 LED lamps with one module
- Fully sealed encapsulated electronics
- Compact Size: 1" x 3/4" x 3/4" with 6" color-coded wire leads

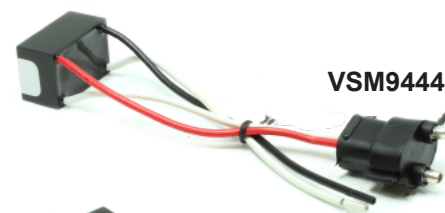

VSM9444



VSM9446

Accesorios de Montaje

Stop/Tail/Turn Lamp to Vehicle Harness Plug Adapters



VSM9420
Grote Harness to Standard 3-Pin
 Adapts Grote harness to industry standard 9128 3-pin termination



VSM9425
Grote Male Pin Lamp to 3-Pin Harness
 Adapts Grote male pin lamp to standard 3-pin harness



VSM9421
Grote Harness to Standard 3-Pin
 Adapts Grote harness to industry standard 9124 3-pin termination



VSM9426
Grote Harness to Sure Seal Plug
 Adapts Grote harness to Sure Seal plug LED lamps



VSM9424
Male Pin to Standard 3-Pin
 Adapts male pin lamp to standard 3-pin



VSM9427
Standard Harness to Sure Seal Plug
 Adapts standard harness to Sure Seal plug LED lamps. Replace Truck-Lite 94706

Pigtails



VSM9101
Double Contact
 With in-line guide for lamps with indexing, bayonet, candelabra type bases. All bakelite (e.g., 1157 bulbs)



VSM9102
Single Contact
 For lamps with bayonet, candelabra type bases (e.g., 67, 1156 bulbs)



VSM9103
Single Contact
 For lamps with miniature bayonet type bases (e.g., 1895 bulbs)



VSM9104
Single Contact
 For lamps with bayonet, candelabra type bases. Rubber plug (e.g., 67, 1156 bulbs)



VSM9107
Double Contact
 With 'in-line' guide pin for lamps with indexing, bayonet, candelabra type bases. Rubber plug (e.g., 1157 bulbs)

Accesorios de Montaje

Harness Connectors

VSM91282 2-Plug String Harness

Molded right-angle 2-plug string harness for VSM6000 or VSM6400 series two-lamp auxiliary light panels.

VSM91283 3-Plug String Harness

Molded right-angle 3-plug string harness for VSM6000 or VSM6400 series three-lamp auxiliary light panels.

VSM91284 4-Plug String Harness

Molded right-angle 4-plug string harness for VSM6000 or VSM6400 series four-lamp auxiliary light panels.



VSM9309 3-Strand Plug Harness

For all VSM1000 and VSM1500 series incandescent and LED 3-cluster identification bar lamps.

VSM9339 3-Strand Plug Harness

For all VSM1900 series incandescent and LED 3-cluster identification lamps.



VSM9464 Metri-Pack 4-Wire Harness

22" harness length. 16 gauge wire.

VSM9466 Metri-Pack Cross-Over Harness

78" harness length. 16 gauge wire.



VSM9469 Metri-Pack Daisy Chain Harness

36" harness length. 16 gauge wire.

VSM9470 Metri-Pack 5-Wire Harness

22" harness length. 16 gauge wire.



Accesorios de Montaje

Mounting Grommets

VSM9119 2 1/2" Sealed Lamp Rubber Mounting Grommet

- Mounting cup (open back for 2 3/4" diameter mounting hole)
- For VSM 1010, 1011 and 1015 series lamps
- Size: 3 3/16" diameter x 1 3/16" depth

VSM9119



VSM9156



VSM9156 2 1/2" Sealed Lamp Rubber Mounting Grommet

- Closed back grommet

VSM9139 2" Sealed Lamp Rubber Mounting Grommet

- Mounting cup (open back for 2 5/16" diameter mounting hole)
- For VSM 1030 and 1035 series lamps
- Size: 2 3/16" diameter x 13/16" depth

VSM9139



VSM9159



VSM9159 2" Sealed Lamp Rubber Mounting Grommet

- Closed back grommet

VSM9127 4" Sealed Lamp Rubber Mounting Grommet

- Shock proof
- Black rubberized vinyl
- Replacement mounting grommet for all VSM 4000 series incandescent and VSM 4400 series LED lamps.

VSM9127



VSM9137



VSM9137 4" Sealed Lamp Rubber Mounting Grommet

- Closed back grommet

VSM9526 Oval Lamp Mounting Grommet

- For mounting VSM 6000 series incandescent, VSM 6400 series LED sealed lamps and VSM 9525 mounting bracket.

VSM9526



VSM9167



VSM9167 Oval Lamp Mounting Grommet

- Closed back grommet

VSM9175 Mounting Grommet for Rectangular Lamps

- Fits VSM 4500 series lamps



Grommet/Plug Kits

VSM9219 Mounting Kit for 2 1/2" Lamps

- Includes VSM9119 grommet and VSM9122 plug for VSM 1010, 1011 and 1015 series lamps



VSM9219



VSM9239

VSM9239 Mounting Kit for 2" Lamps

- Includes VSM9139 grommet and VSM9122 plug for VSM 1030 and 1035 series lamps

Accesorios de Montaje

Surface Mount Brackets

VSM9361 Black Surface Mount Bracket

For use with 1500 and 1505 series. Requires VSM9122 pigtail.



VSM9381 Chrome Surface Mount Bracket

For use with 1500 and 1505 series. Requires VSM9122 pigtail.



VSM9387 White ABS Header Mount Bracket

For use with 1500 and 1505 series. Requires VSM9122 pigtail.



VSM9393 Gray Branch Deflector Mount Bracket

For use with 1500 and 1505 series. Includes hot wire.



VSM9389 Gray Surface Mount Bracket

For use with 1900 series incandescent and 1905 series LED lamps. Requires VSM9122 pigtail.



VSM9391 Branch Deflector

For use with 1010, 1011, 1015 and 1025 series. Requires VSM9119 and VSM9122.



VSM9395 Branch Deflector

For use with 1030 and 1035 series. Requires VSM9139 and VSM9122.

VSM9397 2" L Mounting Bracket

For use with 1030 and 1035 series. Requires VSM9139 and VSM9122.



VSM9398 2 1/2" L Mounting Bracket

For use with 1010, 1011, 1015 and 1025 series. Requires VSM9119 and VSM9122.

VSM9238 Steel Mounting Bracket with Flange

4 1/2" hole for mounting 4" lamps
Powder coated black steel housing
Mounting: Two 3/8" diameter holes on 4" centers



VSM9237 Steel Mounting Bracket without Flange

4 1/2" hole for mounting 4" lamps



Mounting Accessories

Mounting Accessories

Stainless Steel Oval Lamp Panels Hi-Polished HD Corrosion-Resistant



VSM9525 Black Powder Coated Single Hole Bracket Steel, 8.25 Inch, Accommodates 1 Lamp

VSM9564 Four-Hole Oval Lamp Bracket
Stainless Steel, 33 Inch, Accommodates 4 Lamps



Stainless Steel Bezel

VSM9824 Stainless Steel Trim Ring for 4 Inch Lamp
Fits All 4 Inch Diameter Round Lamps

Chrome Bezels Chrome-Polished High-Impact Plastic Bezels

Features:

- Includes Stainless Mounting Screws
- Fits All Standard Mounting Applications



VSM9812 2 Inch Round Bezel without Visor
Fits All 2 Inch Diameter Round Lamps

VSM9810 2.5 Inch Round Bezel without Visor
Fits All 2.5 Inch Diameter Round Lamps

VSM9814 4 Inch Round Bezel without Visor
Fits All 4 Inch Diameter Round Lamps

Visored Chrome Bezels



VSM9813 2 Inch Round Bezel with Visor
Fits All 2 Inch Diameter Round Lamps

VSM9811 2.5 Inch Round Bezel with Visor
Fits All 2.5 Inch Diameter Round Lamps

VSM9815 4 Inch Round Bezel with Visor
Fits All 4 Inch Diameter Round Lamps

Oval Chrome Bezels



VSM9816 6 Inch Oval Bezel without Visor
Fits All 6 Inch Oval Lamps

VSM9817 6 Inch Oval Bezel with Visor
Fits All 6 Inch Oval Lamps

VSM9866 6 Inch Oval Bezel
Fits VSM6664 Oval Surface Mount LED Lamp



VSMB105

- The perfect way to store spare sealed beams, H1-904 headlamp and assorted bulbs and fuses so that they will always be handy when needed.
- Rattle-free compartments securely hold and protect components. Special “inside lid” compartment makes it easy to find the proper fuse when needed.
- The bright red case is constructed of hi-density polyethylene to withstand rugged use and provide long life
- Case features an internal hinge and sturdy clasp.
- Overall Size: 7” (H) x 11” (W) x 9” (D)

Suggested B105 Hi-Way Safety Box Combinations

The case is sold empty. The following are only suggested parts. You may tailor your items to your own specifications and needs.

Qty.	Description	Qty.	Description	Qty.	Description
1	6062 Hi-Lo Beam	1	4651 High Beam	1	6064 Hi-Lo Beam
1	4064 Stop/Tail/Turn	1	4652 Low Beam	1	4064 Stop/Tail/Turn
1	Relay	1	4064 Stop/Tail/Turn	1	Relay
1	Heavy Duty Flasher	1	Relay	1	Heavy Duty Flasher
2	1157 or 1156 Bulbs	1	Heavy Duty Flasher	2	1157 or 1156 Bulbs
2	194 of 1895 Bulbs	2	1157 or 1156 Bulbs	2	194 of 1895 Bulbs
1	Box Assorted Fuses	2	194 or 1895 Bulbs	1	Box Assorted Fuses
1	Safety Glow Light Stick	1	Box Assorted Fuses	1	Safety Glow Light Stick
		1	Safety Glow Light Stick		



VSM300

- Case with mounting bracket only.
- Tube will hold three all sizes 15 minute fusees or three 20 minute wire/no spike fusees.
- Size: 2.75” x 12” long.



VSM300S

- Case with mounting bracket only.
- Tube will hold three sizes 15 - 20 - 30 minute fusees or three 20 minute spike fusees.
- Size: 2.75” x 19” long.

Reflectores



VSM20

Retro-Flex Adhesive-Backed Reflectors

Features:

- Ultra Thin Design. Just .012" Thick.
- Easy to Install on Flat or Curved Surfaces.
- Industrial Strength Adhesive.
- Meets/Exceeds Requirements of ASTM D4956 and SAE DOT (SAE J594f)



VSM22A

Rectangular with Adhesive Back

- Size: 2 3/4" W x 1 3/4" H

VSM20 Red Rectangular Reflector. Adhesive Back.

Round with Adhesive Back

- Size: 2.88" Diameter

VSM22 Red Round Reflector. Adhesive Back.

VSM22A Amber Round Reflector. Adhesive Back.

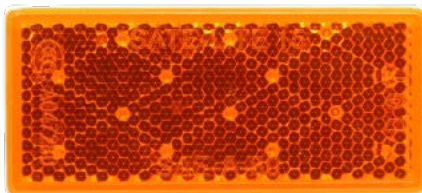

VSM31A

VSM Reflex Reflectors

The following VSM reflectors feature acrylic plastic lenses that are shatter resistant, warp free, and will not fade or craze. Available with universal mounting holes or adhesive back mounting.

Rectangular Reflector with Adhesive Back

Rectangular Reflector with Adhesive Back. Requires No Tools.

- Size: 3 3/16" L x 1 7/8" W 1/4" D • Mounting: Stick-On Clean Flat Surface

VSM31 Red Rectangular Acrylic Reflector. Adhesive Back.

VSM31A Amber Rectangular Acrylic Reflector. Adhesive Back.



VSM32

Rectangular Reflector, Chrome Bezel, Adhesive Back

Rectangular Reflector with Chrome-Plated Bezel. Adhesive Back.

- Size: 3 1/2" L x 1 3/4" W 1/4" D • Mounting: Stick-On Clean Flat Surface

VSM32 Red Rectangular Acrylic Reflector. Adhesive Back.

VSM32A Amber Rectangular Acrylic Reflector. Adhesive Back.



VSM41A

Aluminum Housing - Flush-Type Reflector

Completely Rust-Proof. Protective Guard Shields Lens Against Damage

- Size: 4 1/2" L x 3 3/4" W 3/8" D • Mounting: Two 1/4" Holes at 3 15/16" Centers

VSM41 Red Flush-Type Reflector. Aluminum Housing

VSM41A Amber Flush-Type Reflector. Aluminum Housing



VSM44A

Steel Plated Housing - Armored-Type Reflector

Steel Plated Armored Guard Protects Lens Against Impacts

- Size: 4 1/2" L x 3 3/4" W • Mounting: Two 1/4" Holes at 3 15/16" Centers

VSM44 Red Steel Housing Armored-Type Reflector

VSM44A Amber Steel Housing Armored-Type Reflector

Reflectores

3 Inch Round with Adhesive Back

• Size: 3 3/16" Diameter x 1/4" D • Mounting: Stick-On Clean Flat Surface

- VSM47** Red Round Acrylic Reflector (Adhesive Back)
- VSM47A** Amber Round Acrylic Reflector (Adhesive Back)
- VSM47W** White Round Acrylic Reflector (Adhesive Back)

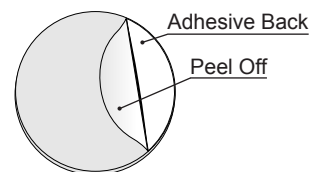

2 Inch Round with Adhesive Back

• Size: 2 3/16" Diameter x 1/4" Depth • Mounting: Stick-On Clean Flat Surface

- VSM53** Red Round Acrylic Reflector (Adhesive Back)
- VSM53A** Amber Round Acrylic Reflector (Adhesive Back)



VSM47

VSM53A

Round Center Hole Reflectors

• Mounting: One #10 Screw • Fast, Permanent Installation with Nail, Screw, or Rivet • 1/4" Reinforced Hole

3 Inch Diameter

• Size: 3 1/4" Diameter x 3/8" D

- VSM57** Red 3 1/4" Round Center Hole Reflector
- VSM57A** Amber 3 1/4" Round Center Hole Reflector

2 Inch Diameter

• Size: 2 3/16" Diameter x 1/4" D

- VSM52** Red 2" Round Center Hole Reflector
- VSM52A** Amber 2" Round Center Hole Reflector

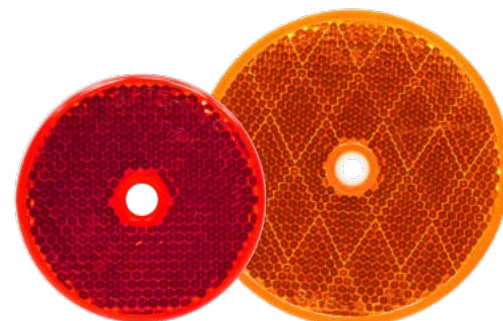

VSM52

VSM57A

Hermetically Sealed Oval Housing Reflectors

• Interchangeable with most Reflectors • Size: 4 3/8" L x 1 7/8" W x 5/16" D

Standard Two Hole Mount

• Mounting: Two #10 Screws at 3 15/16" Centers

- VSM54** Red Standard Two Hole Mount Oval Reflector
- VSM54A** Amber Standard Two Hole Mount Oval Reflector

Adhesive Back or Standard Two Hole Mount

• Can Be Used As Either Stick-On or Standard Two Hole Mount Reflector
 • Mounting: Stick-On or Two #10 Screws at 3 15/16" Centers

- VSM55** Red Oval Reflector for Adhesive Back or Two Hole Mounting
- VSM55A** Amber Oval Reflector for Adhesive Back or Two Hole Mounting

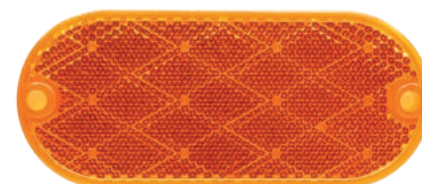

VSM55A

Adhesive Back or Two Hole Mounting

• Fits Between Narrow Rails and In Other Tight Spaces • Size: 1 1/8" W x 4 7/16" L
 • All Standard Applications for Cars, Recreational Vehicles and Trucks
 • Mounting: Stick-On or Two #10 Screws at 3 15/16" Centers

- VSM56** Red Rectangular Reflector for Adhesive Back or Two Hole Mounting
- VSM56A** Amber Rectangular Reflector for Adhesive Back or Two Hole Mounting



VSM56A

Rectangular Conspicuity Strips

• 12" x 1" Strips with End Screws and Adhesive Backer

- VSM58** Red Rectangular Conspicuity Strip
- VSM58C** Clear Rectangular Conspicuity Strip



VSM58

VSM58C

Cinta Reflectiva

Conspicuity Tape

OEM GRADE CONSPICUITY TAPE

Features:

- **Warranty** Manufacturer's seven year-warranty, including high pressure and mechanical wash
- **Durability** Highest performance available polyester-based film resists cracking and lifting. Impact and abrasion resistant
- **Construction** Single ply .008" thin; NOT open cell construction Impact resistant, withstands a hammer blow and still reflects
- **Adhesion** 100% surface adhesion
- **Angularity** Reflects at all applicable angles on the roadway
- **Candle Power** Minimum 100 cpl typically 1000 cpl. exceeding requirements by four times
- **Application** Apply wet or dry, adheres to corners
- **Specifications** Exceeds NHTSA & FHWA specifications, DOT-C2 markings



28



27

For Continuous Side Pattern or Multiple Vehicle Applications

vsm28 7-year DOT tape, 7" white-11" red, 2" x 150' roll

For Non-Continuous Side Pattern Applications

vsm27ST 7-year white DOT tape, 2" x 12" strip

vsm28T 7-year DOT tape, 7" white-11" red 2" x 18" strip

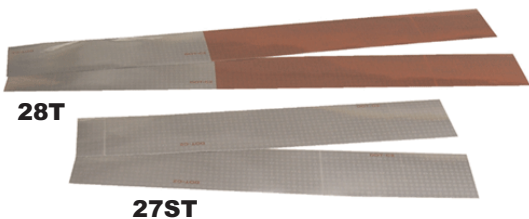

28T

27ST

Recommended Material Requirements for Non-Continuous Side Pattern

Vehicle Length	Recommended No. 18" Strips/Vehicle	Space Between Strips
28 ft.	20	17 ³ / ₈ "
42 ft.	30	16 ³ / ₄ "
45 ft.	32	16 ³ / ₄ "
48 ft.	34	16 ⁷ / ₈ "
53 ft.	38	16 ³ / ₈ "

Note: the above table represents minimum amount of material specified by NHTSA. Additional material may be used to improve the overall conspicuity of the vehicle.

DAYBRIGHT CONSPICUITY TAPE

Features:

- An excellent choice to retrofit older trailers and equipment
- Gives an enhanced daytime appearance on trucks and trailers
- Typically exceeds 600 cpl, 2.5 times greater than DOT-C2 brightness requirements
- Alternating 11" red x 7" white pattern
- Virtually unbreakable; single ply material is .008" thin, no open cells
- Withstands impact damage without losing reflectivity
- 100% permanent surface adhesion
- 3-year manufacturer's warranty including pressure washing
- Reflects light at all applicable angles on the road
- Can be applied wet or dry



29

For Continuous Side Pattern or Multiple Vehicle applications

vsm29S 3-year white DOT tape, 2" x 150' roll

vsm29 3-year DOT tape, 7" white-11" red, 2" x 150' roll

vsm30 3-year DOT tape, red/white 2" x 150' roll

Kisscut - precut every 18" at color break



29S

For Non-Continuous Side Pattern Applications

vsm29ST 3-year white DOT tape, 2" x 12" strip

vsm29T 3-year DOT tape, 7" white-11" red, 2" x 18" strip



29T



29ST



VSM3120 Junction Box

- Universal 7-position junction box with replaceable terminal block
- Extra strong, black non-corrosive construction
- Terminal grommets included
- Size: 8" L x 4" W x 8" H
- Mounting: Two holes on 7 11/32" centers



VSM326 Self-Adjusting Back-Up Alarm

- 87-112 db, Digital Circuitry, 12-24 Volt Operation
- Encapsulated circuit protects against moisture, vibration, shock
- .8 Amp (or less) current draw
- Conform to CE and UL standards
- Tough polypropylene housing
- Mounting: 4" (L) x 5" (W) x 3.11" (H)

VSM322 Back-Up Alarm

- 97 db, Digital Circuitry, 12-24 Volt Operation
- Encapsulated circuit protects against moisture, vibration, shock
- 1/2 Amp (or less) current draw
- Meets all standards SAEJ994
- Tough Nylon Housing
- Mounting: Base 3 1/4" Center; Rear: 3 - 3.5" Center



VSM40 Round Document Holder

- Convenient way to protect and store documents
- Cam-On Opaque cover with gasket seal ensures moisture resistance
- UV-resistant polycarbonate lens and housing
- Retaining springs hold documents in place



VSM39 Manifest Document Holder

- Convenient way to protect and store documents
- Lightweight aluminum, stainless steel hinge/latch
- Outside: 13" x 8" x 1 1/2"
- Inside 11 1/2 x 6 1/2" x 1 1/4"

Accesorios



- VSM9900** King Pin Lock
- A security collar on the king pin of a trailer
 - Prevents theft by obstructing locking-on of the fifth wheel
 - Easily installed or removed proper key
 - Useful as internal trailer control
 - Common key available



- VSM12000** Glad Hand Lock
- Low cost theft deterrent
 - Fits 99% of all glad hands
 - Easy to install and remove
 - Used in “spotting” trailers
 - Available keyed alike



- VSM10GHG** Glad Hand Grip
- 1/2” NPT
 - Quick, easy disconnect for air hose connection
 - Machined steel core

- D.O.T. standard red and blue grips
- Made in the U.S.A.

VSM27000 Heavy Duty Circuit Tester



- Checks all 6 and 12 volt systems
- Tests circuits on trucks, trailers, SUVs, cars, motorcycles, boats, mopeds
- 5 feet of heavy gauge wire

- Spring-supported strain relief
- Heavy-duty ground clip and insulator
- Impact and chemical resistant housing



VSM796 Triangular Safety Emblem

- Triangular warning safety emblem meets DOT standards
- For use on vehicles on public roads moving slower than 25 MPH
- Size: 16" W x 14" H x 3/8" thick
- Mounting: Two 9/32" diameter holes on 6" centers

VSM798 Fold-Up Window-Mount Caution Triangle



VSM799 Fold-Up Safety Arrow with Magnetic Mounts

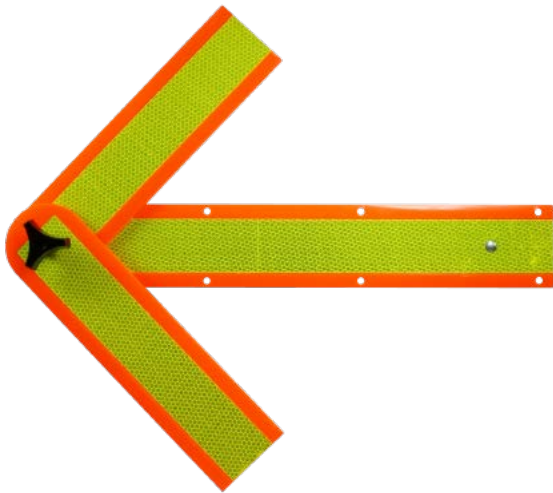

VSM799

















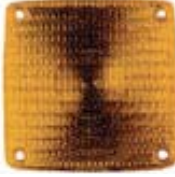











Replacement Lenses



Replacement Lenses

Lentes De Reemplazo

Note: Part numbers are for red lenses unless otherwise noted. For other colored lenses, add suffix for (A) amber, (W) Clear (for accessory use only).

 <p>VSM88307 Flash Tube</p>	 <p>VSM88310 Quad Flash Tube</p>	 <p>VSM88315 Quad LED Strobe Tube</p>	
 <p>VSM9069A 1313A Lamp Lens</p>	 <p>VSM9078A 4800 Series GMC Park Lens</p>	 <p>VSM9079A 4842 Lamp Lens Kit</p>	 <p>VSM9085A 303A Strobe Lens</p>
 <p>VSM9093 1259 Series Lamps</p>	 <p>VSM9113A 310A High-Profile Strobe Lens</p>	 <p>VSM9113AL 310AL Low-Profile Strobe Lens</p>	 <p>VSM9372 548 and 549 Series Lamps</p>
 <p>VSM9373W 548 and 549 Series Lamps Clear Lens with Switch Hole</p>	 <p>VSM9372W 549W Clear Backup Lens</p>	 <p>VSM9374A 307A, 313A Strobe Lens</p>	
 <p>VSM9005A 1101 Series Lamps</p>	 <p>VSM9006 1200 Series O-Ring Lens Kit</p>	 <p>VSM9007 & VSM9007A 1203/1211 Series Lamps</p>	 <p>VSM9008A 1301 Series Lamps</p>
 <p>VSM9011A 1261 Series Lamps</p>	 <p>VSM9014 1559 Series Lamps</p>	 <p>VSM9016 2600/2700/2800/3600/3700/3800 Series Lamps</p>	 <p>VSM9016K 2600/2700/2800/3600/3700/3800 Series Lens Kit</p>
 <p>VSM9029W 4211W Lamps</p>	 <p>VSM9030 4000 Series Lamps</p>		 <p>VSM9049 4011-4029 & 5013-5024 Series</p>
 <p>VSM9055W 420 Series Lamp Lens & Cover</p>	 <p>VSM9059A 1550 Series Lamp</p>	 <p>VSM9063 4800 Series Lamp Lens Kit</p>	



Product Interchange

Referencia para Intercambio de Productos

GROTE

GROTE Part No.	VSM Part No.	CODE	GROTE Part No.	VSM Part No.	CODE	GROTE Part No.	VSM Part No.	CODE	GROTE Part No.	VSM Part No.	CODE	GROTE Part No.	VSM Part No.	CODE
4450	262	D	44810	557	C	46873	2311A	NH	52892	6064	A	60301	1900W	D
10073	7311	C	44820	558	C	46882	107	B	52893	6064A	A	60351	438	D
10073	7323	C	44890	287	D	46883	107A	B				61491	548SW	D
10073	7324	D	45022	1001	D	47072	2105	C	52912	4023	D	61491	549SW	D
12072	7052	C	45023	1001A	D	47073	2105A	C	53000	3812	C	62021	92W	D
12111	7053	C	45142	1900V24	D	47082	1505	B	53020	2803	C	62151	4211W	C
12164	7048	C	45143	1900AV24	D	47083	1505A	B	53023	2803AA	C	62171	4063W	C
12182	7046	C	45162	1500V24	D	47092	1905	B	53032	3712	D	62231	6064W	D
12201	7038	C	45163	1500AV24	D	47093	1905A	B	53052	2702	D	62251	6054W	D
12320	7039	C	45172	1105	D	47102	1040	C	53062	5364	NH	62291	548W	D
16023	7084	C	45173	1105A	D	47112	1035	B	53063	5364A	NH	62291	549W	D
16053	7085	C	45262	1259	A	47113	1035A	B	53132	548	C	64071	675W	D
16092	7083	C	45263	1259A	A	47122	1015	A	53133	548A	C	64111	651W	D
16202	7055	D	45333	1312A	D	47123	1015A	A	53252	4454	B	64111	656W	D
16212	7004	C	45462	1233	D	47183	1376A	C	53252	4464	A	64231	653W	D
28032	7310	C	45463	1233A	D	47212	1045	C	53253	4454A	C	64314	652W	D
40052	47	C	45812	1010	A	47213	1045A	C	53253	4464A	A	64441	650W	D
40053	47A	C	45813	1010A	A	47222	1055	C	53282	4467	C	64441	725056	D
40072	53	C	45821	1030W	D	47223	1055A	C	53283	4467A	C	64890	625H	D
40073	53A	C	45822	1030	A	48072	900	A	53292	4468	C	64930	620H	D
40092	52	C	45823	1030A	A	48072	901	C	53293	4468A	C	64931	620W	B
40093	52A	C	45832	1011	A	48192	900Y155	D	53712	5013	C	64931	725058	C
40132	56	C	45832	1101	C	48272	902	C	53773	4064A	A	64940	630H	D
40133	56A	C	45833	1011A	A	48282	999282	C	55092	4211	C	64941	630W	D
40152	57	C	45833	1101A	C	49002	1003	D				66830	9424	NH
40153	57A	C	45932	1222	C	49072	1215	D				66831	9421	NH
40232	41	C	45932	1261	C	49140	9313	C				66843	9128	A
40233	41A	C	45933	1222A	C	50232	4112	C	55470	4842	C	67000	9124	A
41022	42	C	45933	1261A	C	50232	4212	C	55572	4063	D	67006	9426	NH
41023	42A	C	45993	1340A	D	50502	4522	C	55612	4111	C	67010	9123	D
41032	54	C	46292	1559	D	50852	522	D	55702	5014	C	67011	9420	NH
41033	54A	C	46293	1559A	D	50852	4029	C	55722	5015	C	67050	9122	A
41042	55	C	46412	1500	A				55722	5016	C	68680	9464	C
41043	55A	C	46413	1500A	A				55762	5023	C	69500	900Y96	D
41121	58C	NH	46433	1385A	NH	50942	4012	C	55890	4852	C	69530	900Y114	D
41122	58	NH	46543	1320A	D				55900	4853	C	69540	900Y129	C
43022	9392	D	46742	1900	A	50952	4011	C	56000	3802	C	69550	900Y150	A
43362	9525	B	46743	1900A	A				56020	2801	C	69560	902Y19	C
43362	9561S	C	46782	1203	A	50972	4027	C	56032	3711	D	69580	915Y105	D
43370	9387	D	46783	1203A	A	52202	4564	C	56052	2701	D	69590	915Y103	D
43380	1241	C	46792	1211	A	52203	4564A	C	60001	420W	A	69600	900Y170	D
43424	51	C	46793	1211A	A	52513	6164A	C	60011	422W	C	69610	905Y104	D
43572	9238	C	46813	1310A	C	52543	6154A	C	60011	4212W	C	69610	915Y113	C
43830	15729	D	46813	1375A	C	52602	4028	C	60101	430W	D	69610	99610	NH
43980	9391	D	46832	2300	NH	52770	4066	D	60151	431W	D	69620	915Y104	D
44450	129	C	46833	2300A	NH	52772	4064	A	60261	1502W	D	69650	900Y73	C
44540	263	D	46872	2101	C	52782	4054	A	60271	1500W	D	69660	900Y100	D
44710	254	D	46872	2311	NH	52783	4054A	A	60280	1501		69690	99690	NH
44810	257	D	46873	2101A	C	52882	4068	B	10202C	1010WV24		71152	796	D

POPULARITY CODE:

A = Fastest moving • B = Very active • C = Steady movement • D = Stock only as demand dictates • ** = OEM p/n's • NH = New part number no sales history

Referencia para Intercambio de Productos

GROTE

GROTE Part No.	VSM Part No.	CODE	GROTE Part No.	VSM Part No.	CODE
71422	798	D	481187	999295	NH
73040	322	D	481381	999827	NH
73050	325	D	481385	999495	NH
73080	326	D	484071	999574	A
76033	333A	D	484075	999575	A
76033	381A	D	484371	999839	NH
76035	381B	D	644471	725018	D
76202	374	D	43411-3	50	C
76203	374A	D	43673-5	9179	C
76205	374B	D	48272/69510	900Y112	C
76332	370	D	48272/69510	905Y112	D
76803	6200A	C	48272/69530	900Y101	D
77043	310A	D	48272/69680	903	D
77083	310ALP	D	60081-3	9192	D
90011	9029W	D	82-2160	9406	NH
90012	9029	D	82-2161	9405	NH
90013	9029A	D	82-2163	9407	NH
90051	9005A	C	82-2164	9501	NH
90052	9005	D	82-2164	9502	NH
90053	9005W	C			
90122	9093	C			
90123	9093A	C	82-2167	9401	NH
			82-2311	4745	D
90762	9031	C	82-2312	4744	D
90971	H3-55		83-6006	9602	NH
91302	9049	C	83-6006-3	9603	NH
91400	9119	A	83-6018	9614	NH
91582	9016K	D	83-6018-3	9615	NH
91583	9016AK	D	83-6026	9616	NH
91740	9127	A	83-6026-3	9617	NH
91962	9007	B	83-6104	9604	NH
91963	9007A	B	83-6116	9610	NH
91964	9007G	D	83-8003	3004	NH
91965	9007B	C	85-6028	9606	NH
92183	1375AM	NH			
92420	9526	B			
92452	367	D			
92453	367A	D			
92583	9375	C			
92701	H3-100				
93455	367B	D			
94100	9139	C			
94100	9239	D			
94180	9175	C			
99595	9039	B			
102014	7044	C			
167244	7000	C			
481177	999177	D			
481182	999182	NH			



Product Interchange

Referencia Cruzada de Productos

PETERSON

PETERSON Part No.	VSM Part No.	CODE	PETERSON Part No.	VSM Part No.	CODE	PETERSON Part No.	VSM Part No.	CODE	PETERSON Part No.	VSM Part No.	CODE	PETERSON Part No.	VSM Part No.	CODE
45	50	C	142ABS	1010ABS	D	335	2801	C				608	7046	C
95A	1550A	D	142R	1010	A	335-2	2803	C				608	7311	C
95R	1550	D	142R-24V	1010V24	D	337	3802	C	445	4027	C	615	7000	C
98A	1301A	D	143-18	9119	A	337-2	3812	C	445-25	9071	C	618	7083	C
101-15A	9005A	C	143-18	9219	D	352A	6164A	C	446	5014	C	754A	352A	D
101-15R	9005	D	143A	1011A	A	352KA	6154A	C	446-09	9464	C	754R	352	D
101R	1105	D	143A-24V	1011AV24	D	352R	6164	D	446L	5013	C	755R	370	D
101Y	1105A	D	143FA	1010AF	D	389	9367SW	C	447	5023	C	759A	374A	D
106	1261	C	143FR	1010F	D	391	548SW	D	448	4029	C	759B	374B	D
106-09	9179	C	143R	1011	A	393	548W	D	448	5015	C	759R	374	D
107-3A	109A	C	143R-24V	1011V24	D	393C	92W	D	449	798	D	790A	303A	D
107-3R	109	C	145A	1040A	C	400	420W	A	454	4028	C	809	7310	C
107A	107A	B	145KS	1040ABS	D	410-15R	9029	D	455-25	9049	C	830	7052	C
107R	107	B	145R	1040	C	410-15Y	9029A	D	459	796	D	831	7053	C
			146-18	9139	C	410-21	9039	B	470A	42A	C	M110R	1001	D
109A	1312A	D	146-18K	9239	D	410-25R	9031	C	470R	42	C	M110Y	1001A	D
110-15A	9004A	C	146A	1030A	A	411R	4211	C	472A	41A	C	M124A	1101A	C
110-15B	9004B	D	146C	1030W	D	411SR	4111	C	472R	41	C	M124R	1101	C
110-15C	9004C	D	146FA	1030AF	C	413	4112	C	475A	47A	C	M150A	1500A	A
110-15C	9004G	D	146FR	1030F	C	415	4063W	C	475R	47	C	M150C	1502W	D
110-15R	9004	C	146R	1030	A	416	6064C	C	477A	52A	C	M150R	1500	A
111R	1003	D	146SA	1030ASF	D	416K	6054C	C	477R	52	C	M150W	1500W	D
118-15A	9067A	D	146SR	1030SF	D	417-491	9427	NH	479A	54A	C	M153A	1505A	B
118A	1320A	D	150-092/142-49			417-491MP	9426	NH	479R	54	C	M153R	1505	B
134-15A	9093A	C	9381	C		420-2	6464	A	480A	55A	C	M154A	1900A	A
134-15R	9093	C	150-14	15729	D	421-09	9525	B	480R	55	C	M154C	1900W	D
135A	1259A	A	150-141	15730	D	421-18	9526	B	481A	53A	C	M154C	1901W	D
135R	1259	A	150-3A	1503A	D	421-49	9130	C	481R	53	C	M154R	1900	A
138-15A	9007A	B	150-3R	1503	D	421-491	9128	A	483A	31A	C	M158-1A	2105A	C
138-15C	9007C	C	150-49	9309	C	421A	6064A	A	483R	31	C	M158-1R	2105	C
138-15G	9007G	D	154-09K	9389	C	421KA	6054A	B	486A	57A	C	M161A	1905A	B
138-15R	9007	B	155A	2101A	C	421KR	6054	B	486R	57	C	M161R	1905	B
138-18B	9007B	C	155R	2101	C	421R	6064	A	487A	56A	C	M162A	1015A	A
138A	1211A	A	164FA	1035AF	C	424	9123B	D	487R	56	C	M162R	1015	A
138A-V24	1211AV24	D	164FR	1035F	C	424R	4068	B	500	900	A	M163FA	1015AF	D
138B	1211B	D	166A	1045A	C	426-09	9237	C	500	901	C	M163FR	1015F	D
138B-24V	1211BV24	D	166R	1045	C	426-18	9127	A	504HT	625W7935	C	M164KR	1035K	C
138C	1211C	D	306A	548A	C	426A	4064A	A	505	642WK	D	M164KY	1035AK	C
138C-24V	1211CV24	D	306R	548	C	426KA	4054A	A	507	620W	B	M164R	1035	B
138G	1211G	D				426KR	4054	A	507LU	620H	D	M164Y	1035A	B
138G-24V	1211GV24	D				426R	4064	A	549	H3-100		M2760A	4464A	A
138R	1211	A				428	522	D	550	H3-55		M2760AF-2	4458A	C
138R-V24	1211V24	D				429R	4066	D	555	580K	NH	M2875A	6464A	B
139R	1203	A	326	4842	C	431-49	9123	D	570	250	D	M350A	6564A	C
139Y	1203A	A	326-15A	9079A	D	431-491	9124	A	571	252	D	M413	4212	C
142-09	9391	D	334-15A	9016AK	D	435	431W	D	600	7038	C	M417KR-2	4454	B
142-49	9122	A	334-15R	9016K	D	436	422W	C	602	7048	C	M417R-2	4464	A
142A	1010A	A	334-15R	9021	D	438	430W	D	603	7039	C	M418R-2	4468	C
142A-24V	1010AV24	D	334-15Y	9021A	D	442	4011	C	603L	7044	C	V418KR-2	4458	C

POPULARITY CODE:

A = Fastest moving • B = Very active • C = Steady movement • D = Stock only as demand dicates • ** = OEM p/n's • NH = New part number no sales history

Product Interchange

Product Interchange



Referencia Cruzada de Productos

PETERSON

SIGNAL-STAT

PETERSON Part No.	VSM Part No.	CODE	SIGNAL-STAT Part No.	VSM Part No.	CODE	SIGNAL-STAT Part No.	VSM Part No.	CODE	SIGNAL-STAT Part No.	VSM Part No.	CODE	SIGNAL-STAT Part No.	VSM Part No.	CODE
V7004	9813	NH	31ADB	31A	C	625W	625W7935	C	900Y177	900Y177	D	915Y114	915Y114	C
V7005	9812	NH	31DB	31	C	630H	630H	D	900Y179	900Y179	D	915Y117	915Y117	C
V7006	9811	NH	41A	41A	C	630W	630W	D	900Y209	900Y209	D	915Y118	915Y118	D
V7007	9810	NH	41R	41	C	640WK	642WK	D	901	901	C	915Y119	915Y119	D
V7008	9815	NH	42AD	42A	C	650W	650W	D	901Y108	901Y108	D	915Y120	915Y120	D
V7009	9814	NH	42D	42	C	650W	655W	D	901Y109	901Y109	D	915Y122	915Y122	D
V7010	9817	NH	45A	53A	C	651W	656W	D	901Y73	901Y73	D	915Y124	915Y124	C
V7011	9816	NH	45R	53	C	656W	653W	D	902	902	C	915Y703	915Y703	B
			47-3	47	C	656W	658W	D	902Y108	902Y108	D	915Y704	915Y704	D
			47A-3	47A	C	675W	675W	D	902Y110	902Y110	D	920	920	D
			50	50	C	677W	652W	D	902Y115	902Y115**	**	935	935	D
			51	51	C	689D	H3-55		902Y116	902Y116**	**	950	950	D
			52-3	52	C	699-4	H3-70V24		903	903	D	955	955	D
			52A-3	52A	C	699D	H3-100		905	905	C	956AA	956AA	D
			54A	54A	C	742	742	C	905Y104	905Y104	D	957AA	957AA	D
			54ATD	55A	C	796	796	D	905Y105	905Y105	D	1001	1001	D
			54R	54	C	798	798	D	905Y106	905Y106	D	1001 A	1001A	D
			54TD	55	C	900	900	A	905Y107	905Y107	D	1003	1003	D
			56A	56A	C	900Y49	900Y49	D	905Y111	905Y111	D	1010	1010	A
			56R	56	C	900Y73	900Y73	C	905Y112	905Y112	D	1010- 4	1010V24	D
			57-3	57	C	900Y80	900Y80	D	905Y113	905Y113	D	1010 A	1010A	A
			57A-3	57A	C	900Y88	900Y88	D	905Y114	905Y114	D	1010A-4	1010AV24	D
			92WD	92W	D	900Y96	900Y96	D	905Y115	905Y115	C	1010W	1010WV24D	
			242	250	D	900Y100	900Y100	D	905Y116	905Y116	D	1011	1011	A
			243	252	D	900Y101	900Y101	D	905Y117	905Y117	D	1011A	1011A	A
			263	558	C	900Y105	900Y105	D	905Y200	905Y200	D	1011A-3	1011AV24	D
			307A	307A	D	900Y106	900Y106	D	905Y206	905Y206	D	1018	1040	C
			311	374	D	900Y110	900Y110	D	910	910	C	1018A	1040A	C
			311A	374A	D	900Y112	900Y112	C	910Y102	910Y102	D	1030	1030	A
			312	370	D	900Y114	900Y114	D	910Y104	910Y104	C	1030A	1030A	A
			313A	313A	D	900Y120	900Y120	D	910Y105	910Y105	D	1030ABS	1030ABS	D
			322	322	D	900Y121	900Y121	D	910Y106	910Y106	D	1030W	1030W	D
			327	325	D	900Y128	900Y128	D	910Y110	910Y110	D	1050	1015R	C
			330	352	D	900Y129	900Y129	C	910Y111	910Y111	D	1050A	1015A	C
			330A	352A	D	900Y137	900Y137	D	910Y112	910Y112	D	1101	1101	C
			333	333	D	900Y14	900Y14	D	910Y113	910Y113	D	1101A	1101A	C
			333A	333A	D	900Y141	900Y141	D	910Y114	910Y114	D	1105	1105	D
			356	326	D	900Y150	900Y150	A	910Y116	910Y116	D	1105A	1105A	D
			420W-3	420W	A	900Y151	900Y151	D	910Y117	910Y117	D	1113	1559	D
			423W	422W	C	900Y155	900Y155	D	910Y601	910Y601	C	1113A	1559A	D
			430W	430W	D	900Y158	900Y158	D	915	915	D	1203	1203	A
			431W	431W	D	900Y160	900Y160	D	915Y102	915Y102	D	1203A	1203A	A
			540	522	D	900Y166	900Y166	D	915y103	915Y103	D	1211	1211	A
			548	548	C	900Y167	900Y167	D	915Y104	915Y104	D	1211A	1211A	A
			548A	548A	C	900Y170	900Y170	D	915Y105	915Y105	D	1215	1215	D
			548SW	548SW	D	900Y171	900Y171	D	915Y107	915Y107	D	1222	1222	C
			580K	580K	NH	900Y173	900Y173	D	915Y109	915Y109	D	1222A	1222A	C
			620H	620H	D	900Y174	900Y174	D	915Y111	915Y111	C			
			620W	620W	B	900Y175	900Y175	D	915Y113	915Y113	C			

Product Interchange



Product Interchange

Product Interchange

Referencia Cruzada de Productos

SIGNAL-STAT

SIGNAL-STAT Part No.	VSM Part No.	CODE	SIGNAL-STAT Part No.	VSM Part No.	CODE	SIGNAL-STAT Part No.	VSM Part No.	CODE	SIGNAL-STAT Part No.	VSM Part No.	CODE
1233	1233	D	4070	6064	A	7323	7323	C	9123	9130	C
1233A	1233A	D	4070A	6064A	A	7324	7324	D	9124	9124	A
1259	1259	A	4071W	6064C	C	8931	9014	D	9127	9127	A
1301A	1301A	D	4072	6054	B	8931A	9014A	D	9128	9128	A
1312A	1312A	D	4073A	6164A	C				9139	9139	C
1320	1320A	D	4073AK	6054A	B	9004	9004	C	9145	9145	D
1340A	1340A	D	4073AK	6154A	C	9004A	9004A	C	9157	9526	B
1360A	1310A	C	4111	4111	C	9004B	9004B	D	9175	9175	C
1400	2101	C	4112	4112	C	9004G	9004G	D	9179	1204	D
1400A	2101A	C	4211	4211	C	9004W	9004C	D	9180	9180	D
1400AK	2102A	C	4212	4212	C	9111A	367A	D	9183	9183	C
1400K	2102	C	4501	4553W	C	9111B	367B	D	9185	130	D
1500	1500	A	4501W	4563	C	9111G	367G	D	9190	9190	C
1500A	1500A	A	4522	4522	C	9179-3	9179	C	9191	9143	C
1500W	1500W	D	4800	4800	C	9179A	1204A	D	9191	9191	D
1502W	1502W	D	4801	4801	D	9005	9005	D	9192	9192	D
1507	107	B	4805	4805	D	9005A	9005A	C	9196	9196	D
1507A	107A	B	4805AAY115	4805AAY115	C	9007	9007	B	9238	9238	C
1508A	109A	C	4805AAY118	4805AAY118	C	9007A	9007A	B	9290S	9562S	C
1508R	109	C	4805AY116	4805AY116	C	9007B	9007B	C	9292	9525	B
1550A	1550A	D	4805AY117	4805AY117	C	9007G	9007G	D	9292S	9561S	C
1550	1550	D	4842	4842	C	9007W	9007C	C	9380SWD	9367SW	C
1900	1900	A	4852	4853	C	9008A	9008A	C	9381	9381	C
1900A	1900A	A	4853	4852	C	9016	9016K	D	9387	9387	D
1900W	1900W	D				9016A	9016AK	D	9391	9391	D
1901W	1901W	D				9016A	9021A	D	9393	1241	C
2660	1255	C				9016W	9021C	D	9393	9393	C
2701	2701	D				9029	9029	D	9397	9397	D
2701A	2701A	D	5013	5013	C	9029A	9029A	D	9420	9420	NH
2702	2702	D	5014	5014	C	9029W	9029C	D	9424	9424	NH
2702A	2702A	D	5015	5015	C	9031	9031	C	9464	9464	C
3051	1035RC	C	5016	5016	C	9039	9039	B	9466	9466	C
3051A	1305AC	C	5023	5023	C	9049	9049	C	9469	9469	C
			6801A	310A	D	9063	9063	D	9470	9470	C
			6801MA	310AM	C	9063A	9063A	D	16000	1035	B
4014A	4063A	D	6810A	310ALP	D	9063A	9083A	D	16000A	1035A	B
			6810MA	310ALPM	C	9067A	9067A	D	17000	1015	A
			7010	7000	C	9071	9071	C	17000A	1015A	A
4017	4011	C	7038	7038	C	9074A	9074A	C	20801	9602	NH
			7039	7039	C	9078	9078A	D	20802	9604	NH
			7044	7044	C				20803	9606	NH
4027	4027	C	7048	7048	C	9079A	9079A	D	2660A	1255A	C
4028	4028	C	7054	7053	C	9093	9093	C	44002	4464	A
4030	4064A	A	7073	7046	C	9093A	9093A	C	92524Y	6200A	C
4040	4064	A	7076	7052	C	9111	367	D			
4041W	4063W	C	7083	7083	C	9119	9119	A			
4042	4054	A	7084	7084	C	9119	9219	D			
4046	4066	D	7085	7085	C	9122	9122	A			
4062	4068	B	7313	7310	C	9123	9123	D			

POPULARITY CODE:

A = Fastest moving • B = Very active • C = Steady movement • D = Stock only as demand dictates • ** = OEM p/n's • NH = New part number no sales history

Referencia Cruzada de Productos

TRUCK-LITE

TRUCK-LITE Part No.	VSM CODE Part No.	TRUCK-LITE Part No.	VSM CODE Part No.	TRUCK-LITE Part No.	VSM CODE Part No.	TRUCK-LITE Part No.	VSM CODE Part No.	TRUCK-LITE Part No.	VSM CODE Part No.	TRUCK-LITE Part No.	VSM CODE Part No.		
129	129	4051	44644RC	15745Y	1505A3	C		30200C	1030W	D	60075Y	6564A	C
172	262	4051A	44644AC	19021R	1989K	D		30200R	1030	A	60083R	6054	B
173	263	4060C	44634W	19021Y	1989AK	D		30200Y	1030A	A	60083Y	6054A	B
282	254	4550	45644	19200C	1900W	D		30221R	1030F	C	60202YR	6064	A
283	255	4550A	45644A	19200R	1900	A		30221Y	1030AF	C	60202Y	6064A	A
285	285	6050	64644	19200Y	1900A	A		30222R	1030SF	D	60204C	6064C	C
300A	307ALED	6050A	64644A	19206	1901W	D		30222Y	1030ASF	D	60215R	6164	D
301A	313ALED	6060C	64634W	19250R	1905	B		30250R	1035	B	60215Y	6164A	C
307A	307A	6810A	310ALP	19250Y	1905A	B	D	30250Y	1035A	B	60250R	6464	A
313A	313A	6810AM	310ALPM	19251R	1905RC	B	C	30251R	1035F	C	60284C	6054W	D
548	548	6811A	310A	19251Y	1905AC	B		30251Y	1035AF	C	60700	9526	B
620W-4	620WV24	6811MA	310AM	19721	9389	C		30401	9239	D	60703	9816	NH
630H	630H	7232	1375AM	20201Y	2101A	C		30700	9139	C	60705	9817	NH
630W	630W	9424	9424	21002R	2102	C		30705	9812	NH	60720	9525	B
650W	655W	10050R	1015K	21002Y	2102A	C		33050R	3305				
900	900	10050Y	1015AK	21051R	2105K	C		33050Y	3305A				
901	901	10202R	1010	21051Y	2105AK	C		33060C	3305W				
902	902	10202Y	1010A	21201R	2101	C					60739	9564	C
903	903	10205R	1011	21251R	2105	C					62291	549W	
905	905	10205Y	1011A	21251Y	2105AK	C		40002R	4054	A	70300	3805	D
910	910	10250R	1015	22202Y	2264A	NH		40002Y	4054A	A	70310R	2803	C
1050	1015X	10250Y	1015A	25760Y	1310A	C		40201R	4063	D	80220	4411LED	
1050A	1015AX	10251R	1015F	26301R	1259	A		40202R	4064	A	80311R	4027	C
1051	1015RC	10251Y	1015AF	26301Y	1259A	A		40202Y	4064A	A	80330R/L	4011	C
1051A	1015AC	10700	9119	26302R	1211	A		40204	4063W	C			
1155	155	10700	9219	26302Y	1211A	A		40222R	4067	B			
1155A	155A	10719	9811	26303R	1203	A		40222Y	4067A	B			
1264	1261	10725	9391	26303Y	1203A	A		40223R	4068	B	80334R	4212	C
1264A	1261A	10740	9810	26304R	1261	C		40223Y	4068A	B	80339R	4522	C
1319	1301	10744R	1013	26304Y	1261A	C		40700	9127	A	80360	620W	B
1319A	1301A	15008R	1550	26311R	1559	D		40705	9814	NH	80362	630W	D
1350A	1346A	15008Y	1550A	26311Y	1559A	D		40719	9237	C	80380	5014	C
1507	107	15011	15011	26315R	1101	C		40720	9238	C	80380R	5013	C
1507A	107A	15012	15012	26315Y	1101A	C		44030R	4454	B	80382	5016	C
1508R	109	15033Y	1581AK	26322R	1001	D		44032R	4457	C	80382R	5015	C
1508Y	109A	15039R	1593K	26322Y	1001A	D		44036R	4458	C	80383	5023	C
1590A	1348AY93	15039Y	1593AK	26330	431W	D		44302R	4464	A	80395	625W7935	C
2660	1255	15200C	1500W	26331	430W	D		44322R	4467	C			
2660A	1255A	15200R	1500	26335	420W	A		44326R	4468	C	81307	4852	C
2753	4801LEDL	15200Y	1500A	26371	422W	C		44700	9815	NH			
2756	4801LEDR	15208	1502W	26720	9179	C		45002	4454	C			
2758	4805LEDR	15250R	1505	26740R	1003	D		45002Y	4554A	C	81310	4842	C
2759	4805LEDL	15250Y	1505A	26742R	1215	D		45004	4453W	C	92560	306A	
3050	1035X	15401	9393	26760Y	1340A	D		45202R	4564	C	92901	322	D
3050A	1035AX	15406	9381	26765Y	1320A	D		45202Y	4564A	C	93906	9309	C
3051	1035RC	15727	9387	29202R	2300			45204	4563W	C	94706	9427	NH
3051A	1035AC	15729	15729	29202Y	2300A			45700	9175	C	94902	9122	A
4050	44644	15730	15730	30050R	1035K	C		60015R	6154	D	94925	9123	D
4050A	44644A	15745R	15053	30050Y	1035AK	C		60015Y	6154A	C	94926	9124	A



Referencia Cruzada de Produc

TRUCK-LITE

TRUCK-LITE Part No.	VSM Part No.	CODE	TRUCK-LITE Part No.	VSM Part No.	CODE
94991	9130	C	99077R	9016K	D
94993	9128	C	99077R	9021	D
95000	9464	C	99077Y	9016AK	D
95000	9466	C	99077Y	9021A	D
95001	9426	H	99112R	9005	D
95007	9469	C	99112Y	9005A	C
96939	9221	D			
97904	9039	B	99128Y	9079A	D
97934	9180	D	99130Y	9074A	C
97980	620H	D	99130Y	9078A	D
97989	625H		99160R	9014	D
98003R	56	C	99160Y	9014A	D
98003Y	56A	C	99164R	9049	C
98004R	42	C			
98004Y	42A	C			
98005R	47	C			
98005Y	47A	C			
98006R	57	C			
98006Y	57A	C			
98007R	52	C			
98007Y	52A	C			
98008R	53	C			
98008Y	53A	C			
98030R	41	C			
98030Y	41A	C			
98031R	54	C			
98031Y	54A	C			
98032R	55	C			
98032Y	55A	C			
98035R	31	C			
98035Y	31R	C			
98153	58C	NH			
98154R	58	NH			
99008R	9029	D			
99008Y	9029A	D			
99039B	9004B	D			
99039G	9004G	D			
99039R	9004	C			
99039Y	9004Y	C			
99053B	9007B	C			
99053G	9007G	D			
99053R	9007	B			
99053Y	9007A	B			
99055R	9093	C			
99055Y	9093A	C			
99065Y	9008A	C			
99067Y	9067A	D			
99068R	9071	C			

POPULARITY CODE:

A = Fastest moving • B = Very active • C = Steady movement



VSM Part Number	Page	VSM Part Number	Page	VSM Part Number	Page	VSM Part Number	Page	VSM Part Number	Page	VSM Part Number	Page
10GHG	119	303A	103	900HD	4	1015	38	1261	70	1592K	67
20	114	306A	104	900Y73	11	1015A	38	1261A	70	1592AK	67
20A	114	306ALED	104	900Y96	13	1015AF	38	1301	61	1593K	41
22	114	307A	104	900Y114	15	1015AK	38	1301A	61	1593AK	41
22A	114	307ALED	104	900Y129	12	1015ASF	38	1310A	61	1900	68
27S	116	310A	103	900Y150	11	1015AX	29	1313A	61	1900A	68
27ST	116	310AD	103	900Y170	15	1015ACX	29	1320A	62	1900W	68
28	116	310ALP	103	900Y206	15	1015F	38	1340A	62	1901W	101
28T	116	310ALPM	103	900Y209	13	1015K	38	1346A	62	1903	75
29	117	310AM	103	901	4	1015RCX	29	1348A	59	1903A	75
29S	117	313A	104	901HD	4	1015SF	38	1348AY93	59	1905	40
29ST	117	315A	103	902	4	1015X	29	1349A	59	1905A	40
29T	117	322	118	903	4	1025	38	1365A	21	1905AC	40
30	117	326	118	905	5	1025A	38	1365AC	21	1905A3	73
31	114	420W	101	905C	5	1025K	38	1365AK	21	1905AX	30
31A	114	426WK	101	910	5	1025AK	38	1385A	60	1905RC	40
32	114	430W	101	910Y601	11	1030	66	1405	63	1905X	30
32A	114	431W	101	915	5	1030A	66	1405A	63	1988K	68
39	118	432W	101	915Y103	13	1030AF	66	1415	63	1988AK	68
40	118	437	102	915Y104	14	1030ASF	66	1415A	63	1989AK	40
41	114	438	102	915Y105	12	1030F	66	1500	67	1989K	40
41A	114	522	48	915Y108	8	1030SF	66	1500A	67	2000	63
44	114	548	49	915Y113	8	1033	74	1500W	67	2000A	63
44A	114	548A	49	915Y114	14	1033A	74	1502W	101	2005	63
47	115	550	49	915Y116	12	1033S	74	1503	74	2005A	63
47A	115	557	19	915Y117	12	1033AS	74	1503A	74	2005AC	63
47W	115	558	19	915Y118	15	1035	39	1503AS	74	2005RC	63
52	115	615W	77	915Y121	14	1035A	39	1503S	74	2011	63
52A	115	620A	76	915Y124	14	1035AF	39	1505	41	2011A	63
53	115	620H	76	915Y702	7	1035AK	39	1505A	41	2015	63
53A	115	620W	76	915Y703	11	1035ASF	39	1505W	41	2015A	63
54	115	620WH3	76	915Y704	13	1035AX	29	1505AC	41	2015AC	63
54A	115	620WH3V24	76	918Y116	16	1035ACX	39	1505AX	29	2015RC	63
55	115	620VV24	76	918Y994	16	1035F	39	1505RC	41	2102	69
55A	115	625H	76	918Y998	16	1035K	39	1505X	29	2102A	69
56	115	625W4651	76	920	16	1035RCX	39	1520	71	2105	42
56A	115	625W7935	76	935	5	1035SF	39	1520A	71	2105A	42
57	115	630A	76	1010	65	1035X	29	1549	70	2105AC	42
57A	115	630W	76	1010A	65	1101	71	1549A	70	2105AK	42
58	115	632W	76	1010AF	65	1101A	71	1550	70	2105K	42
58C	115	635W	90	1010ASF	65	1203	69	1550A	70	2105RC	42
128	19	643W	93	1010F	65	1211	69	1559	71	2264A	59
129	19	645W	91	1010K	65	1211A	69	1559A	71	2300	64
254	19	655W	92	1010AK	65	1215	75	1560AK	67	2300A	64
255	19	663W	94	1010SF	65	1215A	75	1560K	67	2311	64
262	19	665W	77	1011	65	1216	75	1580K	67	2311A	64
263	19	742	113	1011A	65	1216A	75	1580AK	67		
285	19	796	120	1013	74	1255AX	30	1581K	41		
287	19	798	120	1013A	74	1255X	30	1581AK	41		
300	113	799	120	1013S	74	1259	70	1587K	41		
300S	113	900	4	1013AS	74	1259A	70	1587AK	41		



Numerical Index

VSM Part Number	Page	VSM Part Number	Page	VSM Part Number	Page	VSM Part Number	Page	VSM Part Number	Page
2464	64	4063W	100	4468X	28	6091	47	6491RC	37
2464A	64	4064	44	4468RF	30	6091A	47	6492	37
2601	48	4064A	44	4500AK	105	6092	47	6492A	37
2601A	48	4064C	100	4500AM	105	6092A	47	6492AC	37
2702	54	4064W	100	4500K	105	6093	47	6492RC	37
2702A	54	4067	44	4500M	105	6093A	47	6493	37
2705	54	4067A	44	4522	49	6094	47	6493A	37
2705A	54	4068	44	4553W	46	6094A	47	6493AC	37
2705W	54	4068A	44	4554	46	6164A	59	6493RC	37
3000	63	4069	45	4554A	46	6454	33	6494	37
3000A	63	4069A	45	4563W	46	6454A	33	6494A	37
3005	63	4211W	99	4564	46	6454AC	33	6495AC	37
3005A	63	4212	48	4564A	46	6454RC	33	6494RC	37
3005AC	63	4411LED	97	45644	36	6456	34	6553AQ	25
3005RC	63	4415LED	98	45644A	36	6457	34	6553W	24
3120	110	4440	30	46644A	104	6457A	34	6556	25
3305	43	4454	31	4755	118	6457W	34	6557	23
3305A	43	4454A	31	4801	55	6458	35	6557A	23
3305AY180	43	4454AC	31	4801LEDL	58	6458A	35	6564A	59
3305ACY180	43	4454RC	31	4801LEDR	58	6458W	35	6641A	27
3305AC	43	44544	31	4805	57	6459	35	66644A	104
3305B	43	44544A	31	4805AAY115	56	6459A	35	69644A	104
3305BY180	43	4457	32	4805AAY118	56	6459W	35	7464	49
3305G	43	4457A	32	4805AAY2	55	64634W	36	7562D	78
3305GY180	43	4457AC	32	4805AAY4	55	6464	33	9005A	121
3305RC	43	4457RC	32	4805AY116	56	6464A	33	9006	121
3305RCY180	43	4458	32	4805AY117	56	6464AC	33	9006A	121
3305W	43	4458A	32	4805LEDL	58	6464AX	28	9007	121
3305WY180	43	4458AC	32	4805LEDR	58	6464RC	33	9007A	121
3305Y180	43	4458RC	32	5013	51	6464W	99	9007W	121
3305Y183	43	4459	32	5013LED	53	6464X	28	9008	121
3615W	100	4459A	32	5014	51	64641	27	9008A	121
3802	55	4459AC	32	5014Y101	51	64644	36	9011A	121
3802Y67	55	4459RC	32	5014Y102	51	64644A	36	9014	121
3812LED	54	4463W	100	5014LED	53	64644AC	36	9014A	121
4027	50	44631W	100	5015	51	64644RC	36	9016	121
4027LED	53	44634W	36	5016	51	6466	34	9016A	121
4028	50	4464	31	5016LED	53	6467	34	9016AK	121
4028LED	53	4464A	31	5023	51	6467A	34	9016W	121
4029	50	4464AC	31	5023Y102	51	6467W	34	9029	121
4054	44	4464AX	28	5023LED	53	6468	35	9029A	121
4054A	44	4464RC	31	5024	51	6468A	35	9029W	121
4054C	100	4464W	100	5024LED	53	6468AX	28	9030	121
4054W	100	4464X	28	5551DK	106	6468X	28	9030A	121
4057	44	44641	27	6054	45	6468W	35	9049	121
4057A	44	44641A	27	6054A	45	6469	35	9055W	121
4058	44	44644	36	6054W	99	6469A	35	9059	121
4058A	44	44644A	36	6064	45	6469W	35	9059A	121
4059	45	44644AC	36	6064A	45	6491	37		
4059A	45	44644RC	36	6064W	99	6491A	37		
4063C	100	4468AX	28			6491AC	37		



VSM Part Number	Page	VSM Part Number	Page	VSM Part Number	Page	VSM Part Number	Page	VSM Part Number	Page
9059W	121	9339	109	9866	112	999491	9	250-8723-COIL	86
9063	121	9340W	121	9900	119	999495	8	250-8723 -COIL4M	86
9063A	121	9340WL	121	10151	26	999496	9	250-8723-TOW	86
9069A	121	9361	111	10151A	26	999574	11	250-8723-TRL	86
9078A	121	9362W	99	10153	72	999575	11	250-8724-KIT	85
9079A	121	9362WT	99	10153S	72	999587	7	250-8724-TOW	86
9085A	121	9369W	99	1015A3	72	999589	7	250-8724-TRL	86
9093	121	9369WT	99	1015A3S	72	999827	14	250-8921	86
9093A	121	9367SW	99	10351	26	999836	13	01480692	17
9101	108	9367W	99	10351A	26	999839	13	01480693	17
9102	108	9372	121	10353	72	B105	113	01480722	17
9103	108	9372W	121	1035A3	72	250-8098	88	01481177	17
9104	108	9373W	121	10353S	72	250-8098-10M	88	01481180	17
9107	108	9374A	121	1035A3S	72	250-8098-20M	88	01481184	17
9113A	121	9381	111	12000	119	250-8143	88	01481187	17
9113AL	121	9387	111	15011	102	250-8143-10M	88	01481190	17
9119	110	9389	111	15012	102	250-8143-20M	88	01481376	17
9122	107	9391	111	15051	26	250-8149	88	01481382	17
9122Y106	107	9393	111	15051A	26	250-8149-10M	88	01481472	18
9122Y110	107	9395	111	15053	73	250-8149-20M	88	01482878	18
9122Y112	107	9397	111	1505A3	73	250-8150	88	01482879	18
9123	107	9398	111	15053S	73	250-8150-10M	88	01483074	18
9124	107	9420	108	15511	102	250-8150-20M	88	01483087	18
9127	110	9421	108	15512	102	250-8170HD	79	01483096	18
9128	107	9424	108	15729	102	8170-HD-10M	79	01483376	18
9130	107	9425	108	15730	102	8170-HD-20M	80	01483377	18
9134	107	9426	108	19052	26	250-8170-MAG	83	Plan-O-Gram	22
9135	43	9427	108	19052A	26	250-8220-RUL	80		
9137	110	9444	107	19053	73	250-8221-RUL	80		
9139	110	9446	107	27000	119	250-8171HD	81		
9156	110	9464	109	69508W	95	8171-HD-10M	81		
9159	110	9466	109	69514W	95	8171-HD-20M	82		
9167	110	9469	109	69522W	95	250-8185	87		
9170	107	9470	109	88307	121	250-8220-SUL	82		
9170Y116	107	9525	112	88310	121	250-8221-SUL	82		
9175	110	9526	110	88315	121	250-8220	89		
9179	69	9564	112	91282	109	250-8221	89		
9183	20	9810	112	91283	109	250-8222	89		
9185	20	9811	112	91284	109	250-8223	89		
9187	20	9812	112	96951	96	250-8290	89		
9219	110	9813	112	96952	96	250-8615	86		
9221	107	9814	112	726500	76	250-8617	86		
9237	111	9815	112	988172	10	250-8721-KIT	85		
9238	111	9816	112	988173	10	250-8721-COIL	86		
9239	110	9817	112	999124	9	250-8721-COIL4M	86		
9256	107	9824	112	999177	8	250-8721-TOW	86		
9309	109			999182	8	250-8721-TRL	86		
				999282	16	250-8722-KIT	85		
				999295	13	250-8722-TOW	86		
				999392	15	250-8722-TRL	86		
				999490	8	250-8723-KIT	85		

TRAILER EQUIPMENT LOCATION REQUIREMENTS

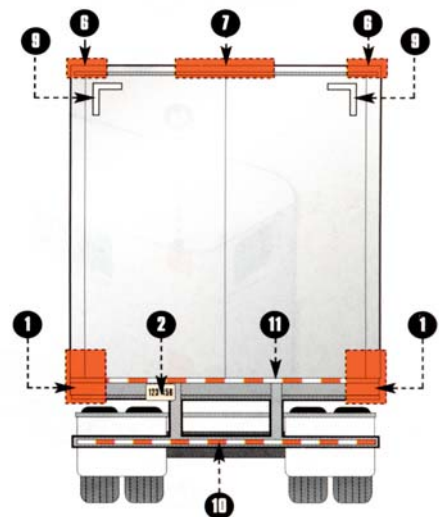
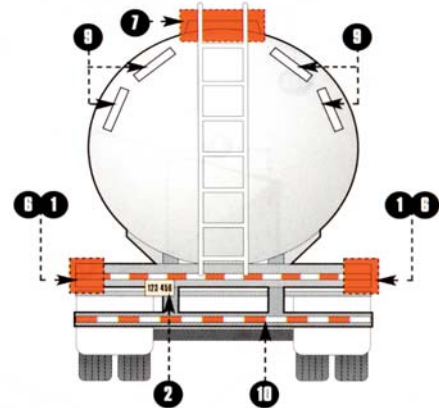
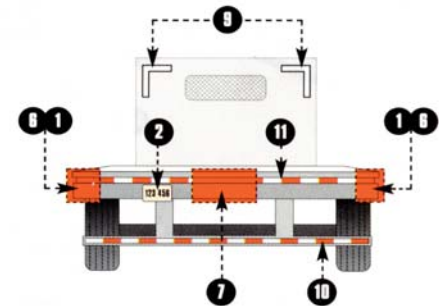
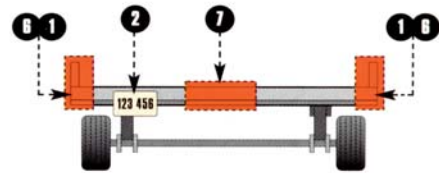
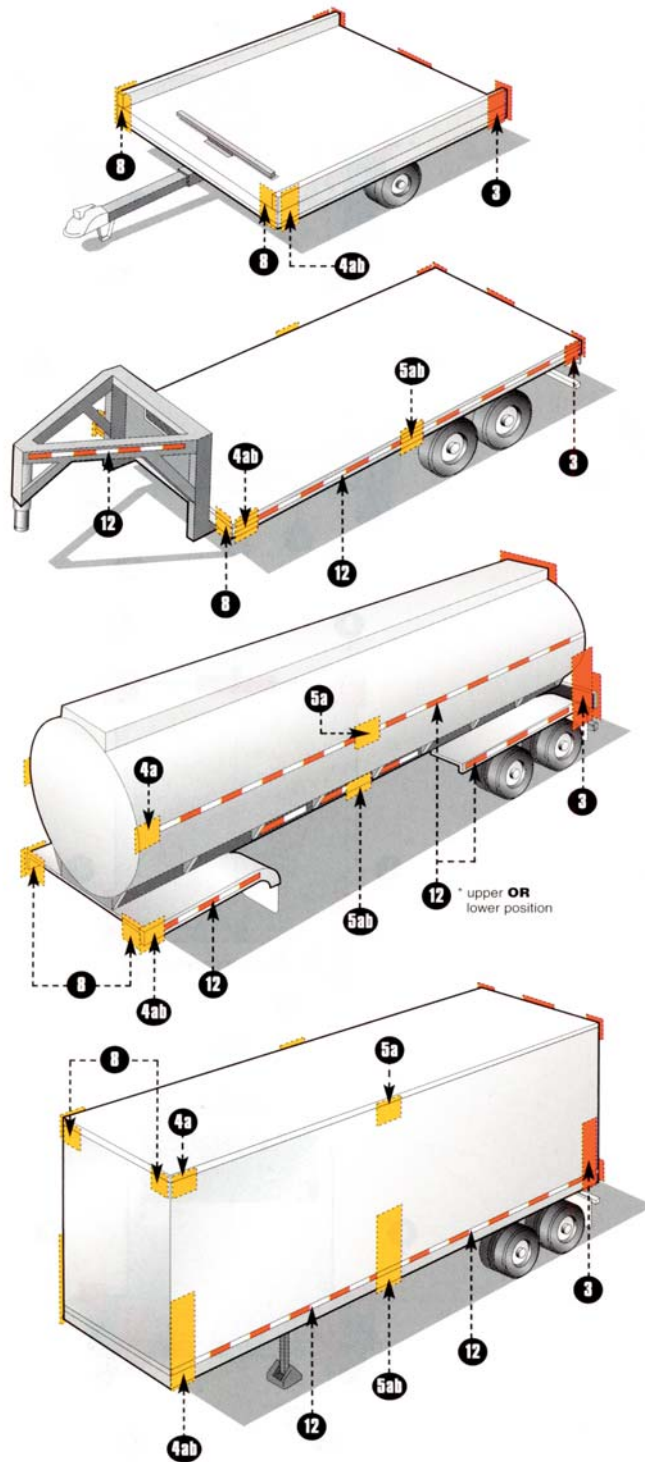

TRAILER EQUIPMENT LOCATION REQUIREMENTS

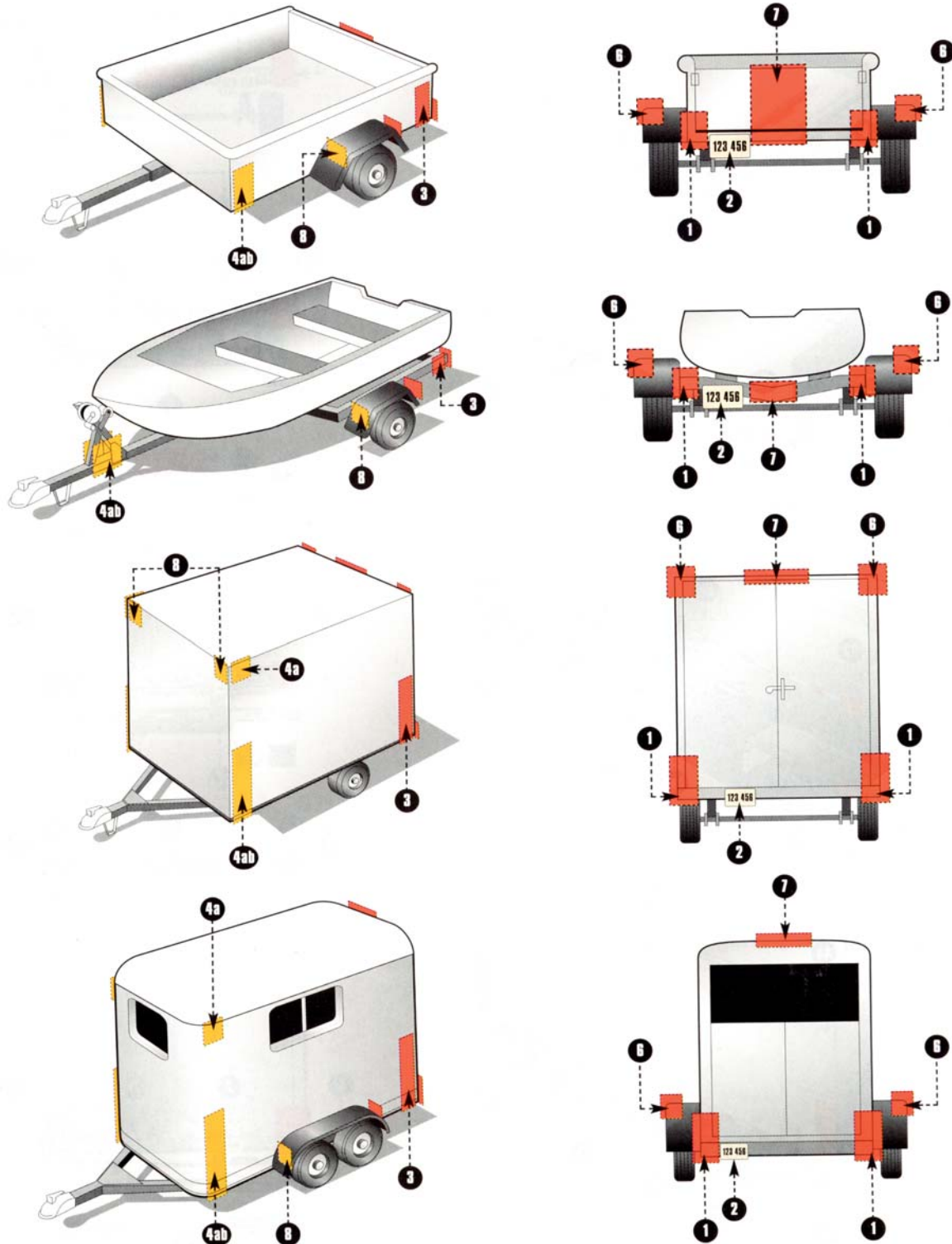

Reglamento Federal de Luces

IMPORTANT NOTE: Every lamp, reflex reflector, and conspicuity treatment must be permanently attached in the location specified below and must comply with all applicable requirements prescribed for it by FMVSS/CMVSS 108. The face of any device on the front/rear and sides should be, respectively perpendicular and parallel to the vehicles centerline unless it is photometrically certified at installation angle. No part of the vehicle shall prevent any device from meeting its prescribed requirements unless an auxiliary device meeting all prescribed requirements is installed. **IN CANADA:** Manufacturers and importers of vehicles must have the proper certification test records demonstrating compliance of lighting components with all prescribed requirements.

BASIC EQUIPMENT REQUIRED ON ALL TRAILERS

DESCRIPTION				MANDATORY REQUIREMENTS			
Area	Equipment	SAE Lens Coding	Functional Purpose	Quantity	Color	Location	Height mm (in.) from ground
1	Tail Lamps	(T)	Indicate vehicle's presence and width	Minimum 2	Red	On the rear - symmetrical as far apart as practicable	380-1830 (15-72)
	Stop Lamps	(S)	Indicate braking	Minimum 2	Red	On the rear - symmetrical as far apart as practicable	380-1830 (15-72)
	Rear Turn Signal Lamps	(I)	Indicate direction of turn	Minimum 2	Red or Yellow	On the rear - symmetrical as far apart as practicable	380-2110 (15-83)
	Rear Reflex Reflectors	(A)	Indicate vehicle's presence and width	Minimum 2	Red	On the rear - symmetrical as far apart as practicable facing forward	380-1530 (15-60)
2	License Plate Lamp(s)	(L)	Illuminates license plate	Minimum 1	White	On the rear - above or at the sides of license plate	No requirement
3	Rear Side Marker Lamps	(P2, PC* OR P3, PC2*) *photometrically certified at installation angle	Indicate vehicle's presence and length	Minimum 2	Red	Each side at rear as far back as practicable	380-1530 (15-60) no max. for veh. under 2032mm (80") wide
	Rear Side Reflex Reflectors	(A)	Indicate vehicle's presence and length	Minimum 2	Red	Each side at rear as far back as practicable facing sideward	380-1530 (15-60)
4	a Front Side Marker Lamps	(P2, PC* OR P3, PC2*) *photometrically certified at installation angle	Indicate vehicle's presence and length	Minimum 2	Yellow	Each side at front as far forward as practicable	380 (15) minimum
	b Front Side Reflex Reflectors	(A)	Indicate vehicle's presence and length	Minimum 2	Yellow	Each side at front as far forward as practicable facing sideward	380-1530 (15-60)

ADDITIONAL EQUIPMENT FOR TRAILERS EXCEEDING THE FOLLOWING PARAMETERS

Length 9.1m (30 ft.) or longer

DESCRIPTION				MANDATORY REQUIREMENTS			
Area	Equipment	SAE Lens Coding	Functional Purpose	Quantity	Color	Location	Height mm (in.) from ground
5	a Intermediate Side Marker Lamps	(P2 or P3)	Indicate presence of a long vehicle	Minimum 2	Yellow	Each side near center facing sideward	380 (15) minimum
	b Intermediate Side Reflex Reflectors	(A)	Indicate presence of a long vehicle	Minimum 2	Yellow	Each side near center facing sideward	380-1530 (15-60)

ADDITIONAL EQUIPMENT FOR TRAILERS EXCEEDING THE FOLLOWING PARAMETERS

Width 2032mm (80 in.) or wider

DESCRIPTION				MANDATORY REQUIREMENTS			
Area	Equipment	SAE Lens Coding	Functional Purpose	Quantity	Color	Location	Height mm (in.) from ground
6	Rear Clearance Lamps	(P2, PC* OR P3, PC2*) *photometrically certified at installation angle	Show vehicle's width MAY NOT be combined with with tail lamps	Minimum 2	Red	At widest point symmetrical on the rear or near the rear facing rearward	As high as practicable may be lower only if ID lamps are at the top
7	Rear Identification (ID) Lamps	(P2 or P3)	Indicate presence of a wide vehicle	Exactly 3	Red	On the rear - centre horizontally spaced 150mm (6 in.) to 300mm (12 in.) apart facing rearward	At the top - may be lower if door header narrower than 25mm
8	Front Clearance Lamps	(P2, PC* OR P3, PC2*) *photometrically certified at installation angle	Show vehicle's width	Minimum 2	Yellow	At widest point symmetrical on the front or near the front facing forward	As high as practicable

ADDITIONAL EQUIPMENT FOR TRAILERS EXCEEDING THE FOLLOWING PARAMETERS

Width 2032mm (80 in.) or wider AND GVWR 4536 kg (10,000 lb.) or more

DESCRIPTION				MANDATORY REQUIREMENTS			
Area	Conspicuity Treatment	DOT Coding	Quantity	Color	Location	Height	Options
9	Rear Upper Body Markings	DOT-C DOT-C2 DOT-C3 DOT-C4	Exactly 2 pairs of 300mm long strips	White	On the rear upper corners facing rearward	At the top	Reflex reflectors may not be required if they are replaced in their required location with conspicuity treatment
10	Bumper Bar Marking	DOT-C DOT-C2 DOT-C3 DOT-C4	Continuous	Red/White	On the rear bumper bar's horizontal element full width - facing rearward	No requirement	Optional in Canada: Rear lower body and side conspicuity treatment may also be solid white, solid yellow, or white and yellow
11	Rear Lower Body Marking	DOT-C DOT-C2 DOT-C3 DOT-C4	Continuous	Red/White (see options)	On the rear full width of the vehicle facing rearward	As horizontal as practicable and as close as practicable to the range of 375 to 1525mm from the ground	
12	Side Marking	DOT-C DOT-C2 DOT-C3 DOT-C4	(see location)	Red/White (see options)	Each side-facing sideward continuous, or evenly spaced over minimum of 50% of length starts and ends as close to the front and rear of the vehicle as practicable	As horizontal as practicable and as close as practicable to the range of 375 to 1525mm from the ground	

NOTE: The edge of red conspicuity tape shall not be closer than 75 mm to the edge of any amber lamp and the edge of white conspicuity tape shall not be closer than 75 mm to the edge of any lamp

TRUCK, BUS, MPV EQUIPMENT LOCATION REQUIREMENTS

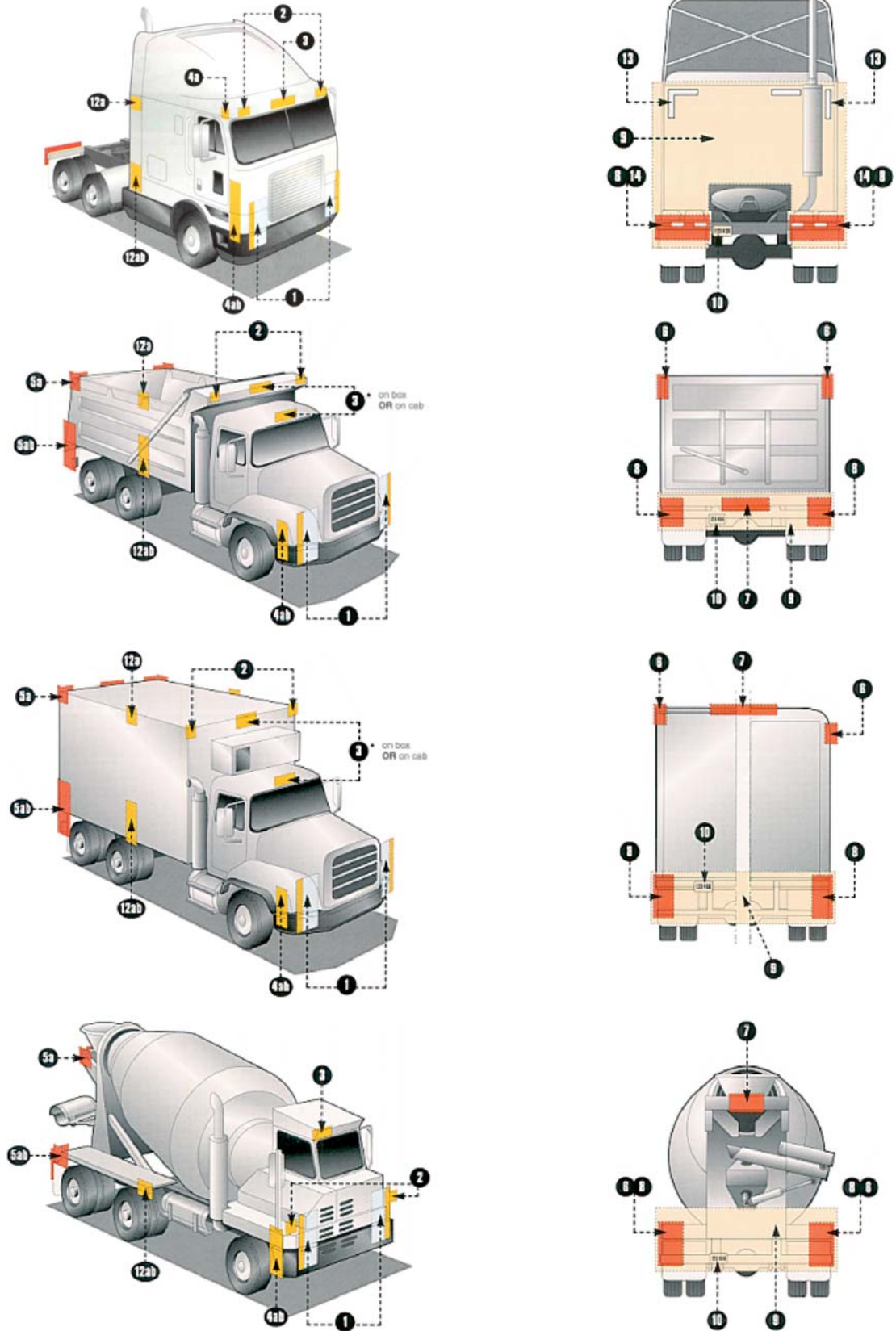

TRUCK, BUS, MPV EQUIPMENT LOCATION REQUIREMENTS

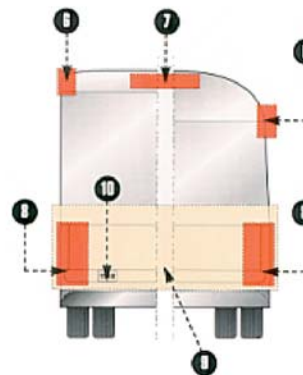
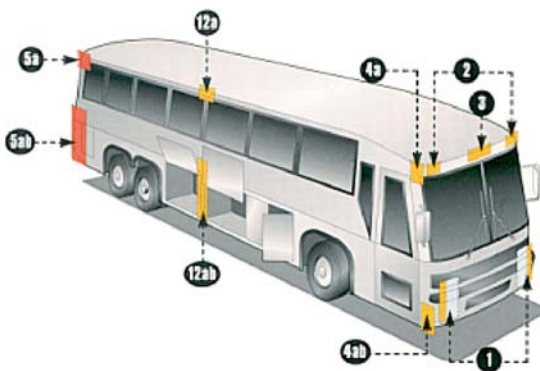
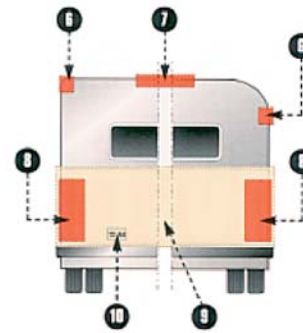
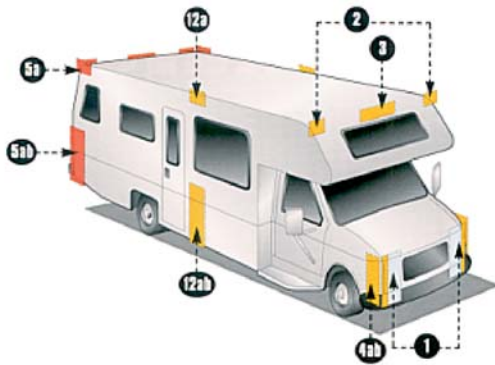
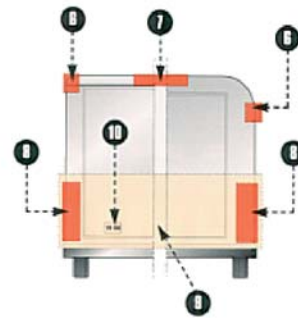
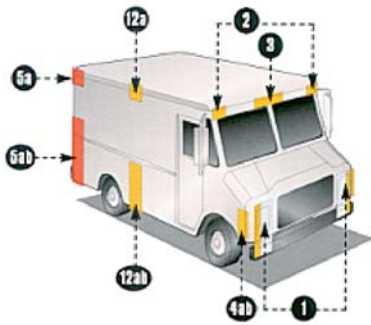



Reglamento Federal de Luces

BASIC EQUIPMENT REQUIRED ON ALL TRUCKS, BUSES & MPVs

		DESCRIPTION		MANDATORY REQUIREMENTS			
Area	Equipment	SAE Lens Coding	Functional Purpose	Quantity	Color	Location	Height mm (in.) from ground
1	Headlamps - Lower Beam	(H, HR) Attention: US: "DOT" lettering required on lens Attention: US & Canada: light source code required on lens	Forward road illumination	Minimum 2	White	On the front - symmetrical - as far apart as practicable (If 4 lamp system - outboard or above upper beams)	560-1370 (22-54)
	Headlamps - Upper Beam	(H, HR) Attention: US: "DOT" lettering required on lens Attention: US & Canada: light source code required on lens	Forward road illumination	Minimum 2	White	On the front - symmetrical (If 4 lamp system - inboard or below lower beams)	560-1370 (22-54)
	Parking Lamps- Attention: Required only on vehicles less than 2032mm wide	(P)	Indicate parked vehicle	Minimum 2	White or Yellow	Front - symmetrical - as far apart as practicable	380-1530 (15-60)
	Daytime Running Lamps	(Y2) Attention: for Canada required, for US optional. Attention: for US, "DRL" lettering required on lens if device is not headlamp	Indicate in-use vehicle	Minimum 2	White or Yellow	Front - symmetrical - as far apart as practicable	380 (15) minimum Maximum depends on type of DRL
	Front Turn Signal/Hazard Warning Lamps	(I)	Indicate direction of turn / identify disabled vehicle	Minimum 2	Yellow	Front - symmetrical - as far apart as practicable	380-2110 (15-83)
	2	Front Clearance Lamps- Attention: Required for vehicles 2032mm wide or wider	(P2, PC* or P3*,PC2) *photometrically certified at installation angle	Show vehicle's width	Minimum 2	Yellow	At widest point - symmetrical - on the front or near the front - facing forward
3	Front Identification Lamps (ID)	(P2 or P3)	Indicate presence of a wide vehicle	Exactly 3	Yellow	On the front - center - horizontally spaced 150 mm (6 in.) to 300 mm (12 in.) apart	As high as practicable or on top of cab
4a	Front Side Marker Lamps	(P2, PC* or P3, PC2*) *photometrically certified at installation angle		Minimum 2	Yellow	Each side at front - as far forward as practicable	380 (15) minimum
4b	Front Side Reflex Reflectors	(A)	Front and Rear side marker lamps / side reflex reflector indicate vehicle's presence and length	Minimum 2	Yellow	At front - symmetrical - as far forward as practicable - facing sideward	380-1530 (15-60)

BASIC EQUIPMENT REQUIRED ON ALL TRUCKS, BUSES & MPVs, cont.

Area	DESCRIPTION			MANDATORY REQUIREMENTS			
	Equipment	SAE Lens Coding	Functional Purpose	Quantity	Color	Location	Height mm (in.) from ground
5a	Rear Side Marker Lamps **	(P2, PC* or P3, PC2*) *photometrically certified at installation angle	Front and Rear side marker lamps / side reflex reflector indicate vehicle's presence and length	Minimum 2	Red	Each side at rear - as far back as practicable	380 (15) minimum
5b	Rear Side Reflex Reflectors** ** not required on Truck Tractors	(A)		Minimum 2	Red	Each side at rear - as far back as practicable - facing sideward	380-1530 (15-60)
6	Rear Clearance Lamps Attention: Required for vehicles 2032mm wide or wider, but not required on Truck Tractors	(P2, PC* or P3, PC2*) *photometrically certified at installation angle	Show vehicle's width MAY NOT be combined with tail lamps	Minimum 2	Red	At widest point - symmetrical - on the rear or near the rear - facing rearward	As high as practicable-may be lower only if rear ID lamps are at the top
7	Rear Identification Lamps (ID) Attention: Required for vehicles 2032mm wide or wider, but not required on Truck Tractors	(P2 or P3)	Indicate presence of a wide vehicle	Exactly 3	Red	Rear - center - horizontally spaced 150 mm (6 in.) to 300 mm (12 in.) apart, facing rearward	<u>in Canada</u> : at the top - maybe lower if door header narrower than 25mm <u>in USA</u> : as high as practicable
8	Tail Lamps	(T)	Indicate vehicle's presence and width	Minimum 2	Red	On the rear - symmetrical - as far apart as practicable	380-1830 (15-72)
	Stop Lamps	(S)	Indicate braking	Minimum 2	Red	On the rear - symmetrical - as far apart as practicable	380-1830 (15-72)
	Rear Turn Signal/Hazard Warning Lamps	(I)	Indicate direction of turn/ identifies disabled veh.	Minimum 2	Red or Yellow	On the rear - symmetrical - as far apart as practicable	380-2110 (15-83)
	Rear Reflex Reflectors	(A)	Show vehicle's presence and width	Minimum 2	Red	On the rear - symmetrical - as far apart as practicable - facing rearward	380-1530 (15-60)
9	Backup Lamp	(R)	Illuminate ground behind the vehicle and alert road users	Minimum 1	White	Rear	No requirement
10	License Plate Lamp(s)	(L)	Illuminates license plate	Minimum 1	White	On the rear - above or at the sides of license plate	No requirement
11	Center High Mounted Stop Lamp Attention: Required for vehicles less than 2032mm wide and 4536kg	(U3)	Indicates braking	Minimum 1	Red	On the rear - centerline of the vehicle	860 (34) minimum



Vehicle Safety Manufacturing, LLC
VehicleSafetyMFG.com

2351 J. Lawson Blvd., Orlando, FL 32824

Phone: (800) 832-7233

LTVSM0221V1